



# **XP-8000-CE6**

## **User Manual**

**(for WinCE 6.0 Based XPAC)**

V1.0.3, March 2018



**XP-8031-CE6/XP-8131-CE6/ XP-8331-CE6/ XP-8731-CE6**

Written by Sean Hsu

Edited by Anna Huang

## Warranty

---

All products manufactured by ICP DAS are under warranty regarding defective materials for a period of one year, beginning from the date of delivery to the original purchaser.

## Warning

---

ICP DAS assumes no liability for any damage resulting from the use of this product. ICP DAS reserves the right to change this manual at any time without notice. The information furnished by ICP DAS is believed to be accurate and reliable. However, no responsibility is assumed by ICP DAS for its use, not for any infringements of patents or other rights of third parties resulting from its use.

## Copyright

---

Copyright © 2018 by ICP DAS Co., Ltd. All rights are reserved.

## Trademark

---

The names used for identification only may be registered trademarks of their respective companies.

### Contact US

If you have any problem, please feel free to contact us.

You can count on us for quick response.

Email: [service@icpdas.com](mailto:service@icpdas.com)

# Contents

|  |           |
|--|-----------|
| <b>1. INTRODUCTION .....</b>                                       | <b>7</b>  |
| 1.1. Features.....   | 8         |
| 1.2. Specifications .....  | 9         |
| 1.3. Overview .....  | 11        |
| 1.4. Dimensions.....   | 19        |
| 1.5. Companion CD.....   | 22        |
| <b>2. GETTING STARTED.....</b>                                     | <b>23</b> |
| 2.1. Mounting the Hardware.....                                    | 24        |
| 2.1.1. Mounting the XP-8000-CE6 .....                              | 25        |
| 2.1.2. Deploying a Basic XP-8000-CE6 System.....                   | 28        |
| 2.1.3. Inserting the I/O Modules .....                             | 30        |
| 2.1.4. Powering up the XP-8000-CE6.....                            | 32        |
| 2.2. Configuring the Boot Mode.....                                | 36        |
| 2.3. Changing the User Interface Language .....                    | 38        |
| 2.4. Using XPAC Utility to Manage the XP-8000 .....                | 40        |
| 2.5. Using Remote Display to Control the XP-8000-CE6 Remotely..... | 41        |
| 2.6. Using DCON Utility Pro Configure I/O Modules .....            | 43        |
| 2.7. Using DCON_CE to Remote Configure the I/O Module.....         | 46        |
| <b>3. TOOLS AND TASKS.....</b>                                     | <b>50</b> |
| 3.1. XPAC Utility.....   | 51        |
| 3.1.1. Menu Bar – File .....                                       | 52        |
| 3.1.2. Menu Bar – Help.....  | 53        |
| 3.1.3. Property Tab - General.....                                 | 54        |
| 3.1.4. Property Tab – General2.....                                | 56        |
| 3.1.5. Property Tab – Display .....                                | 57        |
| 3.1.6. Property Tab – IP Config .....                              | 58        |
| 3.1.7. Property Tab – Network.....                                 | 59        |
| 3.1.8. Property Tab – Device Information.....                      | 62        |
| 3.1.9. Property Tab – Auto Execution .....                         | 63        |
| 3.1.10. Property Tab – Rotary Execution .....                      | 64        |
| 3.1.11. Property Tab – Multi-IO Modules .....                      | 65        |
| 3.2. DCON Utility Pro.....   | 66        |
| 3.3. DCON_CE.....  | 67        |
| 3.4. TaskMgr .....   | 68        |
| 3.5. VCEP .....  | 69        |
| 3.6. Remote_Display .....  | 70        |

|           |   |            |
|-----------|---|------------|
| 3.7.      | SendToCOM.....  | 71         |
| 3.8.      | RegEdit .....   | 72         |
| 3.9.      | ISQLW35 .....   | 73         |
| 3.10.     | INotepad.....   | 74         |
| <b>4.</b> | <b>YOUR FIRST XP-8000-CE6 PROGRAM .....</b>           | <b>75</b>  |
| 4.1.      | Setting up the Development Environment.....           | 75         |
| 4.1.1.    | Preparing the Development Tools .....                 | 76         |
| 4.1.2.    | Installing the XP-8000-CE6 SDK .....                  | 77         |
| 4.2.      | First XP-8000-CE6 Program in VB.NET.....              | 78         |
| 4.2.1.    | Create a new project .....                            | 79         |
| 4.2.2.    | Specify the path of the PAC reference.....            | 82         |
| 4.2.3.    | Add the control to the form .....                     | 84         |
| 4.2.4.    | Add the event handling for the control.....           | 86         |
| 4.2.5.    | Upload the application to XP-8000-CE6 .....           | 87         |
| 4.2.6.    | Execute the application on XP-8000-CE6.....           | 89         |
| 4.3.      | First XP-8000-CE6 Program in Visual C#.....           | 90         |
| 4.3.1.    | Create a new project .....                            | 91         |
| 4.3.2.    | Specify the path of the PAC reference.....            | 94         |
| 4.3.3.    | Add the control to the form .....                     | 96         |
| 4.3.4.    | Add the event handling for the control.....           | 98         |
| 4.3.5.    | Upload the application to XP-8000-CE6 .....           | 99         |
| 4.3.6.    | Execute the application on XP-8000-CE6.....           | 101        |
| 4.4.      | First XP-8000-CE6 Program in Visual C++.....          | 102        |
| 4.4.1.    | Create a new project .....                            | 103        |
| 4.4.2.    | Configure the Platform .....                          | 108        |
| 4.4.3.    | Specify the Libraries of the PAC SDK.....             | 109        |
| 4.4.4.    | Add the control to the form .....                     | 111        |
| 4.4.5.    | Add the event handling for the control.....           | 114        |
| 4.4.6.    | Upload the application to XP-8000-CE6 .....           | 116        |
| 4.4.7.    | Execute the application on XP-8000-CE6.....           | 118        |
| <b>5.</b> | <b>I/O EXPANSION MODULES AND SDKS SELECTION .....</b> | <b>119</b> |
| <b>6.</b> | <b>APIS AND DEMO REFERENCES .....</b>                 | <b>123</b> |
| 6.1.      | PAC Standard APIs for System Operation.....           | 124        |
| 6.1.1.    | VB.NET Demos for PAC Standard APIs.....               | 125        |
| 6.1.2.    | C# Demos for PAC Standard APIs.....                   | 126        |
| 6.1.3.    | Visual C++ Demos for PAC Standard APIs.....           | 127        |
| 6.2.      | PAC Standard APIs for PAC Expansion I/O .....         | 128        |
| 6.2.1.    | VB.net Demos for PAC Expansion I/O.....               | 129        |

|                           |   |            |
|---------------------------|---|------------|
| 6.2.2.                    | C# Demos for PAC Expansion I/O.....   | 131        |
| 6.2.3.                    | Visual C++ Demos for PAC Expansion I/O.....   | 133        |
| <b>7.</b>                 | <b>RECOVERY AND RESTORE .....</b>   | <b>135</b> |
| 7.1.                      | Recovering the XP-8000-CE6.....   | 136        |
| 7.2.                      | Restoring the Rescue CF Card.....   | 140        |
| <b>8.</b>                 | <b>XP-8000-CE6 UPDATES .....</b>  | <b>144</b> |
| 8.1.                      | OS updates .....  | 145        |
| 8.1.1.                    | OS Updates from file.....   | 146        |
| 8.1.2.                    | OS Updates using the Rescue CF Card .....   | 148        |
| 8.2.                      | SDK Updates .....   | 149        |
| 8.2.1.                    | SDK Updates for VB.NET or C#.....   | 149        |
| 8.2.2.                    | SDK Updates for VB.NET or Visual C++ .....  | 151        |
| <b>9.</b>                 | <b>XP-8000-CE6 DOWNLOAD CENTER.....</b>   | <b>153</b> |
| <b>10.</b>                | <b>APPLICATION OF RS-485 NETWORK .....</b>  | <b>155</b> |
| 10.1.                     | Basic RS-485 Network .....  | 156        |
| 10.2.                     | Daisy Chain RS-485 Network.....   | 157        |
| 10.3.                     | Star Type RS-485 Network.....   | 158        |
| 10.4.                     | Random RS-485 Network .....   | 160        |
| 10.5.                     | Master/Slave Settings.....  | 161        |
| 10.5.1.                   | XPAC as a Master (Default).....   | 162        |
| 10.5.2.                   | XPAC as a Slave .....   | 164        |
| <b>TIPS – HOW TO.....</b> |   | <b>166</b> |
| A.                        | How to Use the Printer .....  | 167        |
| A.1.                      | How to Use a Network Printer .....  | 168        |
| A.2.                      | How to Use a USB printer .....  | 170        |
| B.                        | How to Online Debug the XP-8000-CE6 Program.....                                      | 171        |
| C.                        | How to Automatically Synchronize XP-8000-CE6 Clock with an Internet Time Server ..... | 177        |
| D.                        | How to Control the User Account Control in XP-8000-CE6 .....                          | 179        |
| D.1.                      | How to Create a User Account.....   | 180        |
| D.2.                      | How to Telnet to Remote Login the XP-8000-CE6 from PC.....                            | 182        |
| D.3.                      | How to Remove a User Account from the Login List .....                                | 184        |
| E.                        | How to use PACSDK library to program the XP-8000-CE6 .....                            | 186        |
| E.1.                      | How to Read the XPAC Mode with PACSDK library.....                                    | 187        |
| E.2.                      | How to Read the Module ID with XPAC API.....  | 188        |
| E.3.                      | How to Use the Multi-IO Module with XPAC API.....                                     | 189        |
| F.                        | How to update software from XP-8x4x-CE6 or XP-8000-Atom-CE6 to XP-8x3x-CE6 .....      | 191        |
| G.                        | I-8K and I-87K Modules .....  | 192        |



# 1. Introduction



XP-8000-CE6 Series is the new generation Windows CE 6.0 based PACs of ICP DAS. It is equipped with a x86 CPU (1 GHz) dual-core, various connectivity (VGA, USB, Ethernet, RS-232/485) and 0/1/3/7 I/O slot(s) for high performance parallel I/O modules (high profile I-8K Series) and serial I/O modules (high profile I-87K series). The benefits of running Windows CE 6.0 on XPAC include hard real-time capability, small core size, fast boot speed, interrupt handling at a deeper level and achievable deterministic control. XPAC is also capable of running PC-based control software such as Visual Basic .NET, Visual C#, etc. It has all of the best features of both traditional PLCs and Windows capable PCs.

For software copy protection, programmers can design software based on the 64-bit hardware serial number for making software copy protected.

## 1.1. Features

The XP-8000-CE6 offers the most comprehensive configuration to meet specific application requirements. The following list shows the hardware and software features designed to simplify installation, configuration and application.

### Hardware Features

---

- Powerful CPU module: x86 CPU (1 GHz) dual core
- Rich Memories:
  - System Memory: 2 GB DDR3
  - Built-in Flash Disk: 32 GB
  - EEPROM: 16 KB
  - SRAM/MRAM: 512 KB
- VGA Port x 1, USB 2.0 port x 4, Serial port (RS-232/RS-485) x 5
- 64-bit Hardware Serial Number
- Dual Watchdog Timers
- Dual Ethernet Ports (10 M/100 M/1000 M)
- Redundant Power Input
- Operating Temperature: -25 to +75 °C

### Software Features

---

- Windows Compact Edition 6.0
- ASP
- SQL Compact Edition 3.5
- .NET Compact Framework 3.5
- Remote Display
- Built-in OPC Server (Quicker)
- Rich Software Solution – SDK for Microsoft Visual Studio 2005/2008



## 1.2. Specifications

The table below summarizes the specifications of the XP-8000-CE6.

| Models                               | XP-8031-CE6  | XP-8131-CE6  | XP-8331-CE6 | XP-8731-CE6 |
|--------------------------------------|--|--|-------------|-------------|
| <b>OS</b>                            |  |  |             |             |
| OS                                   | Windows CE 6.0   |  |             |             |
| .Net Compact Framework               | 3.5  |  |             |             |
| Embedded Service                     | FTP Server, ASP (Java Script, VB Script), SQL Compact Edition 3.5  |  |             |             |
| SDK Provided                         | DII for Visual Studio .Net 2005/2008   |  |             |             |
| Multilanguage Support                | English, German, French, Spanish, Russian, Italian, Czech, Japanese, Korean, Simplified Chinese, Traditional Chinese |  |             |             |
| <b>CPU Module</b>                    |  |  |             |             |
| CPU                                  | x86 CPU, 1 GHz, dual-core  |  |             |             |
| SDRAM                                | 2 GB DDR3  |  |             |             |
| MRAM , Non-volatile Memory           | 512 KB (Retain memory without battery support)   |  |             |             |
| Flash                                | 32 GB  |  |             |             |
| EEPROM                               | 16 KB  |  |             |             |
| CF Card                              | CF slot with one CF card (support up to 32 GB)   |  |             |             |
| RTC (Real Time Clock)                | Provide second, minute, hour, date, day of week, month, year   |  |             |             |
| 64-bit Hardware Serial Number        | Yes, for software copy protection  |  |             |             |
| Dual Watchdog Timers                 | Yes (0.8 second)   |  |             |             |
| Rotary Switch                        | Yes (0 to 9)   |  |             |             |
| DIP Switch                           | -  | Yes (8 bits)   |             |             |
| Programmable LED Indicator           | 2 (L1 and L2)  |  |             |             |
| <b>VGA &amp; Communication Ports</b> |  |  |             |             |
| VGA Resolution                       | 1400x1050, 1024 x 768, 800 x 600 , 640 x 480   |  |             |             |
| Dual Ethernet Port                   | RJ-45 x 2, 10/100/1000 Base-T (Auto-negotiating, Auto MDI/MDI-X, LED indicators)                                     |  |             |             |
| USB 2.0                              | 4  |  |             |             |
| COM 1                                | RS-232 (Rx/D, Tx/D and GND); non-isolated  | Internal communication with high profile I-87K series modules in slots |             |             |

|                                  |   |   |   |   |
|----------------------------------|---|---|---|---|
| COM 2                            | RS-232 (RxD, TxD and GND); non-isolated   |   |   |   |
| COM 3                            | RS-485 (Data+, Data-); 3000 V <sub>DC</sub> isolated  |   |   |   |
| COM 4                            | RS-232/RS-485 (RxD, TxD, CTS, RTS and GND for RS-232, Data+ and Data- for RS-485); non-isolated |   |   |   |
| COM 5                            | RS-232 (RxD, TxD, CTS, RTS, DSR, DTR, CD, RI and GND); non-isolated                             |   |   |   |
| Audio                            | Microphone-in and Earphone-out  |   |   |   |
| <b>I/O Expansion Slots</b>       |   |   |   |   |
| Number of I/O slots              | 0   | 1   | 3   | 7   |
| Supported I/O modules            | I-8K and I-87K series I/O Modules   |   |   |   |
| <b>Mechanical</b>                |   |   |   |   |
| Dimensions (W x L x H), unit: mm | 137 x 132 x 125   | 169 x 132 x 125   | 231 x 132 x 125   | 355 x 132 x 125   |
| Installation                     | DIN-Rail or Wall Mounting   |   |   |   |
| <b>Environmental</b>             |   |   |   |   |
| Operating Temperature            | -25 °C to +75 °C  |   |   |   |
| Storage Temperature              | -30 °C to + 80 °C   |   |   |   |
| Ambient Relative Humidity        | 10 % to 90 % RH (non-condensing)  |   |   |   |
| <b>Power</b>                     |   |   |   |   |
| Input Range                      | +10 V <sub>DC</sub> to +30 V <sub>DC</sub>  |   |   |   |
| Redundant Power Inputs           | Yes, with one power relay (1 A @ 24 V <sub>DC</sub> ) for alarm                                 |   |   |   |
| Isolation                        | 1 kV  |   |   |   |
| Capacity                         | 2.2 A, 5 V supply to CPU and backplane, 20W in total  | 3.7 A, 5 V supply to CPU and backplane, 1.3 A, 5 V supply to I/O expansion slots, 25 W in total | 3.8 A, 5 V supply to CPU and backplane, 3.2 A, 5 V supply to I/O expansion slots, 30 W in total | 4.0 A, 5 V supply to CPU and backplane, 3.0 A, 5 V supply to I/O expansion slots, 35 W in total |
| Consumption                      | 12W (0.5 A @ 24 VDC)  | 16.6 W (0.69 A @ 24 VDC)  | 16.8 W (0.7 A @ 24 VDC)   | 18 W (0.75 A @ 24 VDC)  |

### 1.3. Overview

The XP-8000-CE6 is equipped with several interfaces and peripherals that can be integrated with external systems. Here is an overview of the components and its descriptions.

#### XP-8031-CE6

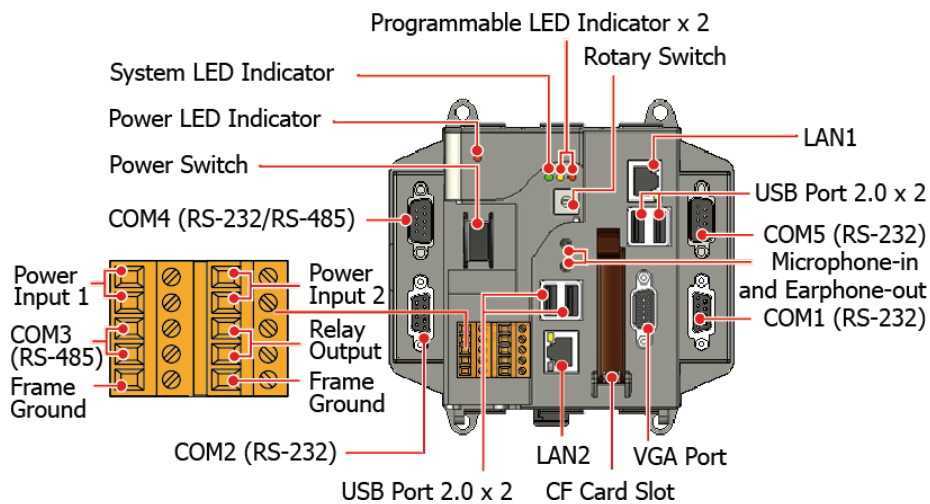

#### XP-8131-CE6

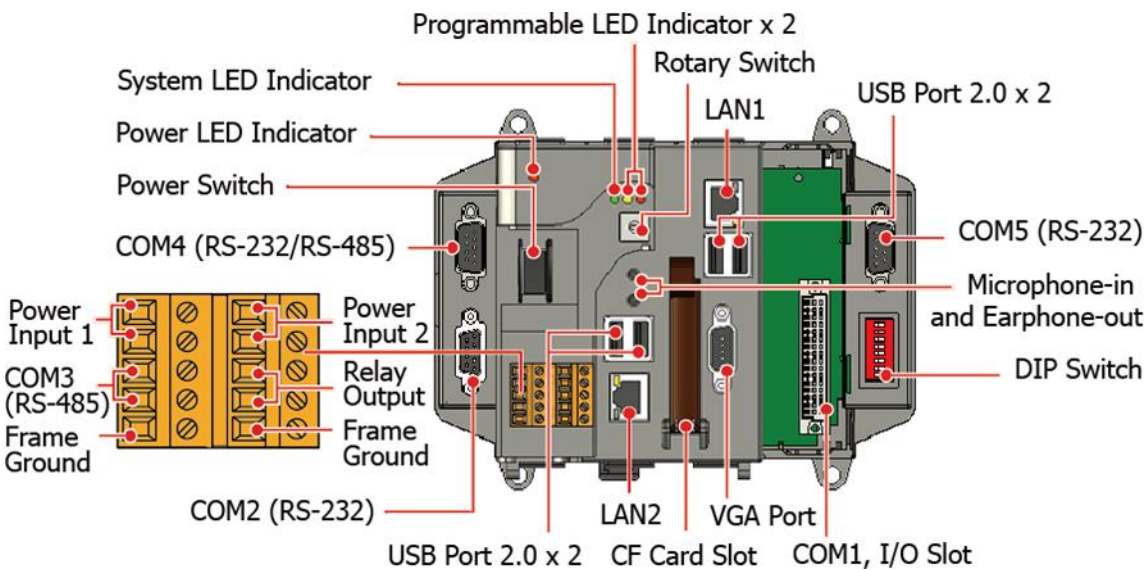

**XP-8331-CE6**

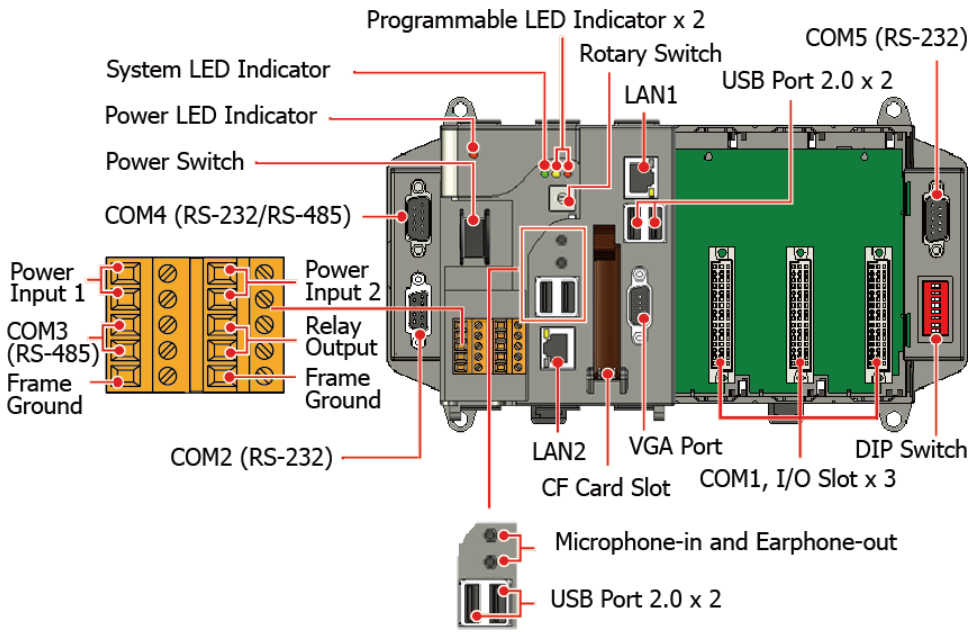

**XP-8731-CE6**

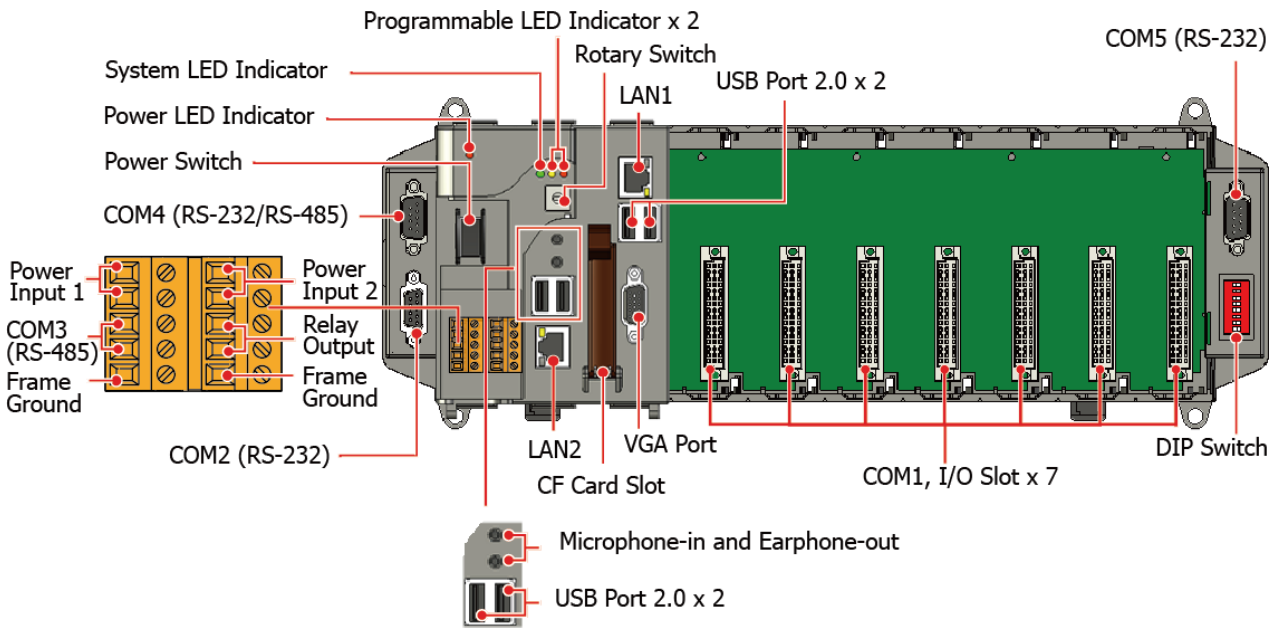

The details of these items are as follows:

## LED Indicators

The XP-8000-CE6 has 4 LED indicators. The first is labeled PWR, located near the power switch and shows the power status. The three other are located next the rotary switch, the left one is labeled RUN and shows the operation status, the two other are denoted L1 and L2 and used for user defined.

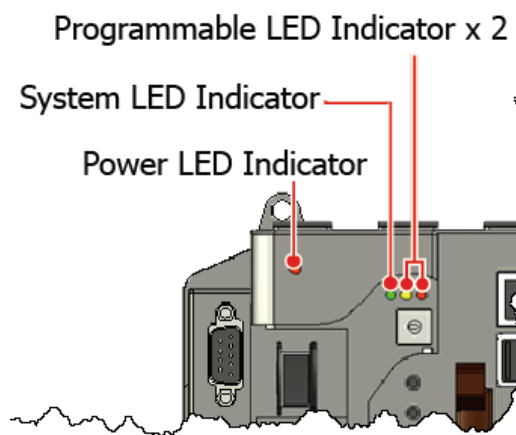

| LED Indicator               | Label     | State (Color) | Meaning                     |
|-----------------------------|-----------|---------------|-----------------------------|
| Programmable LED Indicators | L1 and L2 | -             | Programmable LED indicators |
| System LED indicator        | RUN       | Orange        | OS is running               |
| Power LED Indicator         | PWR       | Green         | Power 1 is on               |

## Operating mode Selector

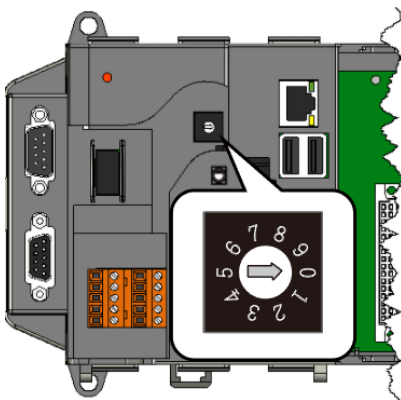

Rotary Switch is an operating mode selector. The XP-8000-CE6 has several operating modes, for more detailed information about these operating mode, please refer to “2.2 Configuring the Boot Mode”

## Power Switch

The power switch is a small switch that enables or disables power to electric circuits and loads in the XP-8000-CE6.

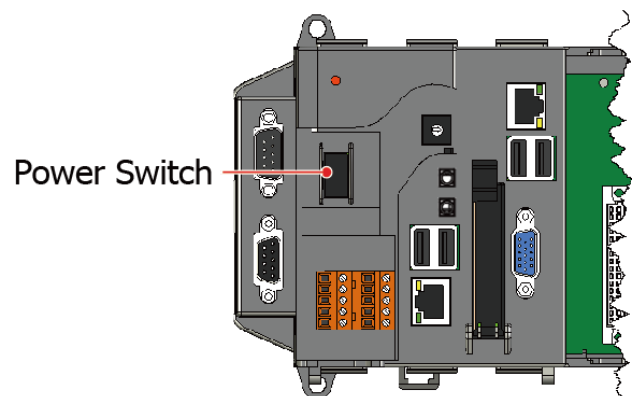

## Redundant Power (PWR1 and PWR2) and relay output

---

The XP-8000-CE6 has a 2-row 10-wire terminal block; there has 4-wire for redundant power inputs and 2-wire for relay output. The details of the redundant power are shown to the side.

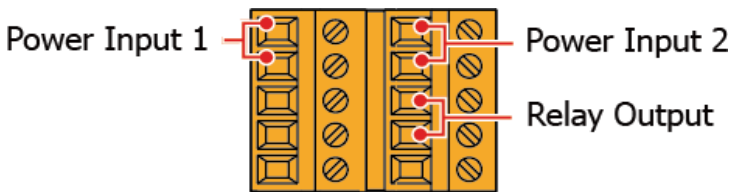

### • Redundant Power

The XP-8000-CE6 provides redundant power that can keep the device running if a problem occurs in the power supply.

### • Relay Output

The XP-8000-CE6 has a relay output that can be used to control a light, siren, or other low voltage device when an alarm occurs.

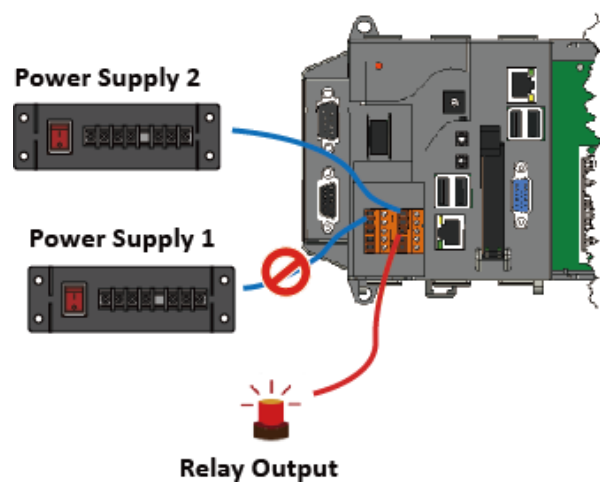

## Communication Ports

---

The XP-8000-CE6 is equipped with several interfaces and peripherals that can be integrated with external systems.

### • VGA Port

The VGA connector is a 3-row 15-pin connector that can be used to connect a monitor at a variety of supported VGA resolutions. and the output resolution covers, 800 x 600, 1024 x768 and 1400 x 1050.

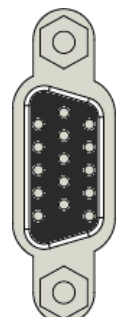

- **CF slot**

The CF slot comes with a free CF card that can be used to restore the system, and expand the memory up to 32 GB.

- **Ethernet Ports (LAN1 and LAN2)**

The XP-8000-CE6 has 2 Ethernet ports that can be used to connect the router to the Internet or to other devices.

Each Ethernet port has 2 LED indicators, which are used to indicate the network speed and Link/Acting, as described below.

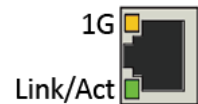

| LED Indicator | State (Color)   | Meaning                  |
|---------------|-----------------|--------------------------|
| 1G            | ON (Yellow)     | Network Speed: 1 GB      |
|               | OFF             | Network Speed: 10/100 MB |
| Link/Act      | ON (Green)      | The Link is active       |
|               | OFF             | The Link is inactive     |
|               | Blinking(Green) | Network activity         |

- **USB Ports (P1, P2, P3 and P4)**

The XP-8000-CE6 has 4 USB 2.0 ports that can be used to connect the USB devices such as mouse, keyboard or an external USB hard drive.

- **Microphone-in and Earphone-out**

The XP-8000-CE6 has a microphone-in and an earphone-out that can be used to process the input and the output of sound.

- **COM1, Expansion I/O Slot (Except XP-8031-CE6)**

The XP-8000-CE6 has 0/1/3/7 I/O slot(s) that can be used to integrate high performance parallel I/O modules (high profile I-8K Series) or serial I/O modules (high profile I-87K series).

- **COM1 (RS-232) (for XP-8031-CE6 only)**

The COM1 port is a 9-pins RS-232 connector. The details of the COM1 port specifications are shown to the side.

**Port Type:** Male

**Baud Rate:** 115200, 57600, 38400, 19200, 9600, 4800, 2400, 1200 bps

**Data Bits:** 5, 6, 7, 8

**Parity:** None, Even, Odd, Mark (Always 1), Space (Always 0)

**Stop Bits:** 1, 2

**FIFO:** 128 bytes

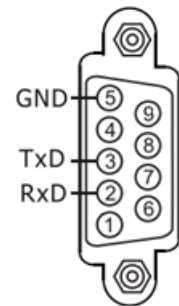

- **COM2 (RS-232)**

The COM2 port is a 9-pins RS-232 connector. The details of the COM2 port specifications are shown to the side.

**Port Type:** Female

**Baud Rate:** 115200, 57600, 38400, 19200, 9600, 4800, 2400, 1200 bps

**Data Bits:** 7, 8

**Parity:** None, Even, Odd

**Stop Bits:** 1

**FIFO:** 1 byte

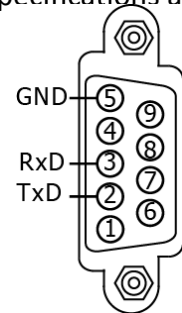

- **COM3 (2-wire RS-485)**

**Port Type:** Terminals

**Baud Rate:** 115200, 57600, 38400, 19200, 9600, 4800, 2400, 1200 bps

**Data Bits:** 5, 6, 7, 8

**Parity:** None, Even, Odd, Mark (Always 1), Space (Always 0)

**Stop Bits:** 1, 2

**FIFO:** 128 bytes

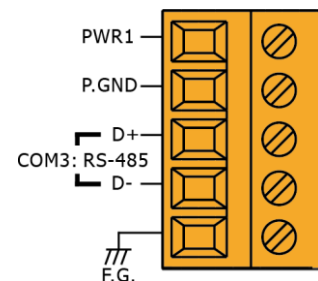



### ● COM4 (RS-232/RS-485)

The COM4 port is a 9-pins RS-232/RS-485 connector. The details of the COM4 port specifications are shown to the side.

**Port Type:** Male

**Baud Rate:** 115200, 57600, 38400, 19200, 9600, 4800, 2400, 1200 bps

**Data Bits:** 5, 6, 7, 8

**Parity:** None, Even, Odd, Mark (Always 1), Space (Always 0)

COM4 can be configured as either RS-232 or RS-485, that only can select configuration depends on the pin connections as follows:

- **RS-232** (RXD, TXD, CTS, RTS and GND)
- **RS-485** (Data+ and Data-)

There is no software configuration or hardware jumper needed.

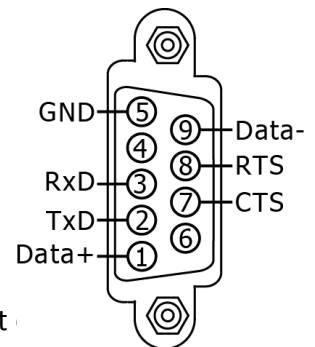

### ● COM5 (RS-232)

The COM5 port is a 9-pins RS-232 connector. The details of the COM5 port specifications are shown to the side.

**Port Type:** Male

**Baud Rate:** 115200, 57600, 38400, 19200, 9600, 4800, 2400, 1200 bps

**Data Bits:** 5, 6, 7, 8

**Parity:** None, Even, Odd, Mark (Always 1), Space (Always 0)

**Stop Bits:** 1, 2

**FIFO:** 16 bytes

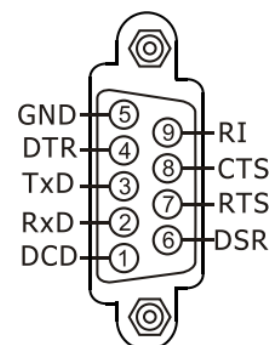

## Tips & Warnings

---



1. All COM ports of XP-8000-CE6 don't support Mark and Space parity settings.
2. The table below shows the data bit and their corresponding stop bit for COM2, COM3 COM4, and COM5

| Word Length | Number of Stop Bits |
|-------------|---------------------|
| 5, 6, 7, 8  | 1                   |
| 5           | 1.5                 |
| 6, 7, 8     | 2                   |

## 1.4. Dimensions

The diagrams below provide the dimensions of the XP-8000-CE6 to use in defining your enclosure specifications. Remember to leave room for potential expansion if you are using other components in your system.

The height dimension is the same for all XP-8000-CE6. The width depending on your choose of I/O expansion slots. All dimensions are in millimeters.

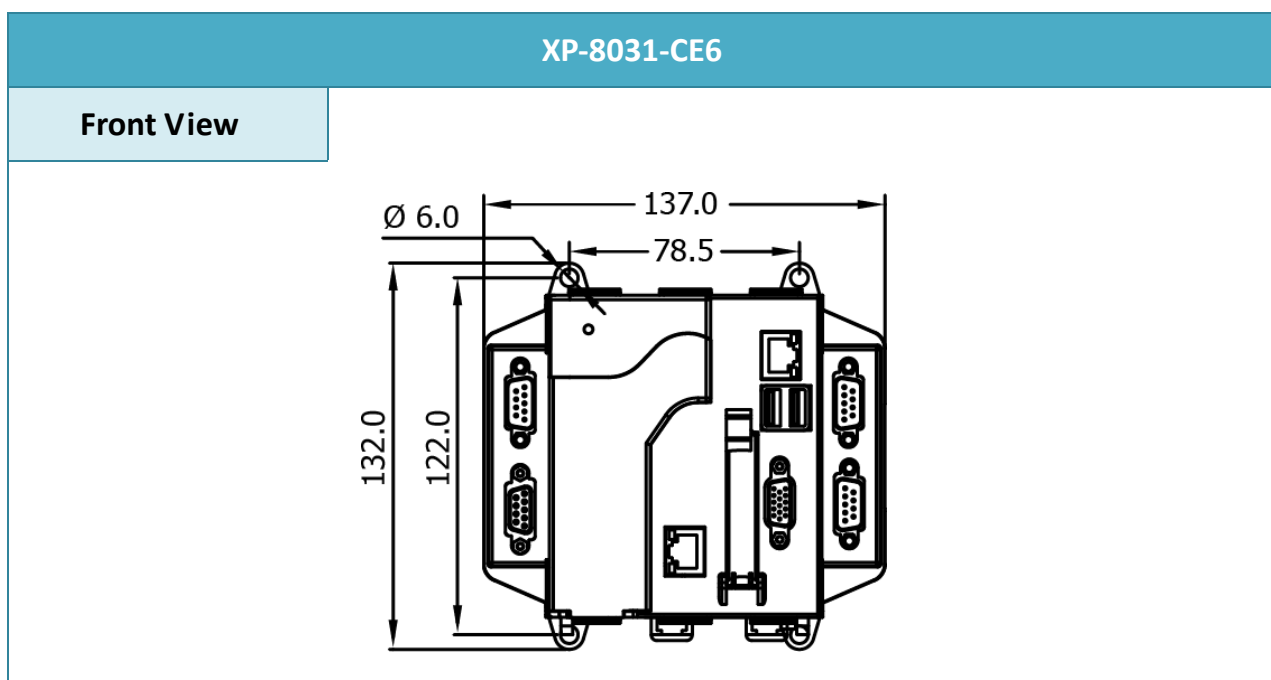
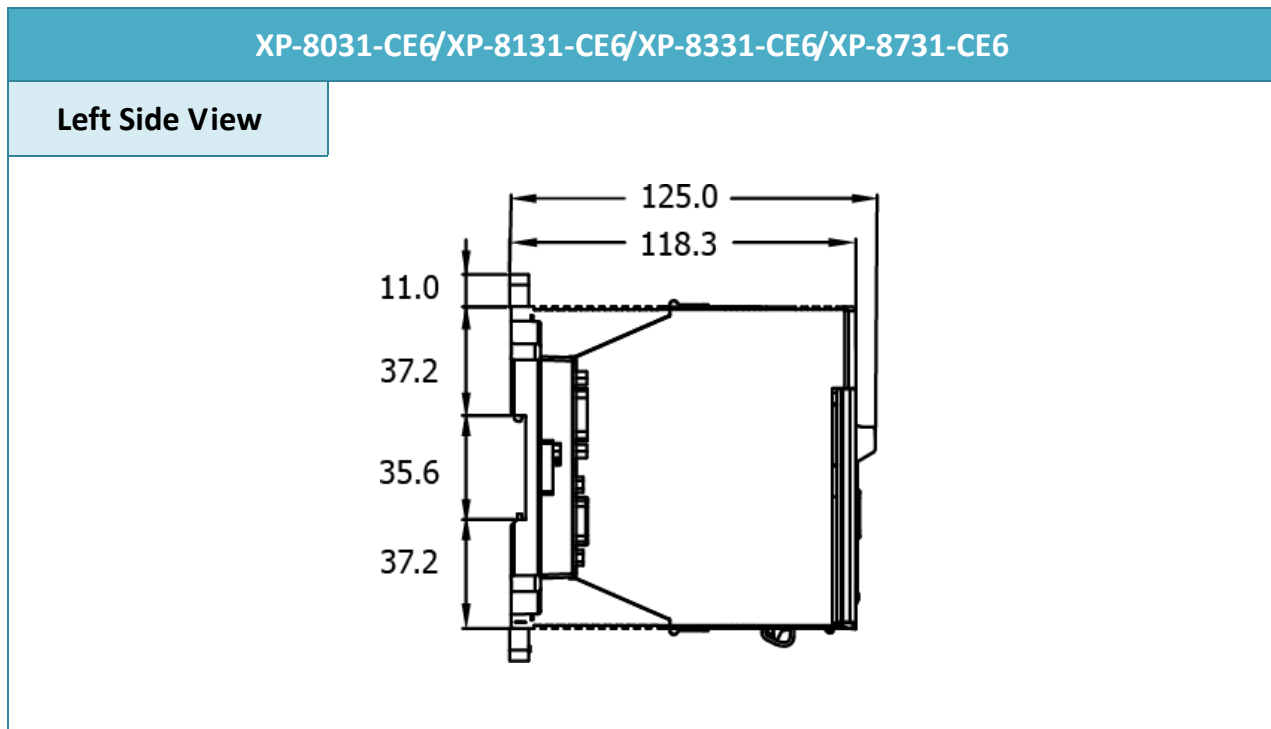

## XP-8131-CE6

### Front View

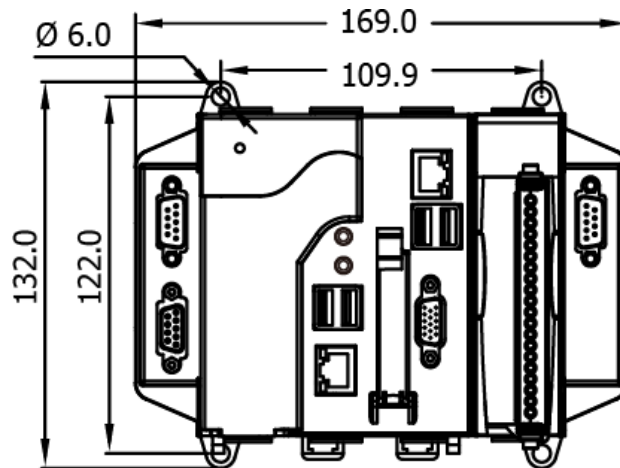

## XP-8331-CE6

### Front View

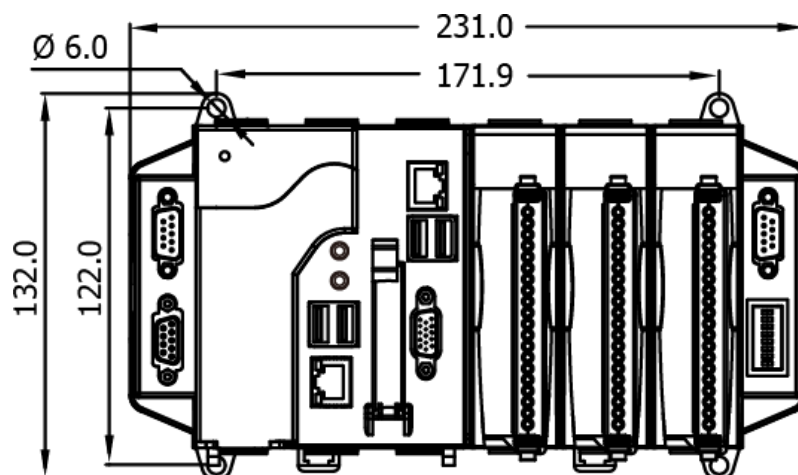

Front View

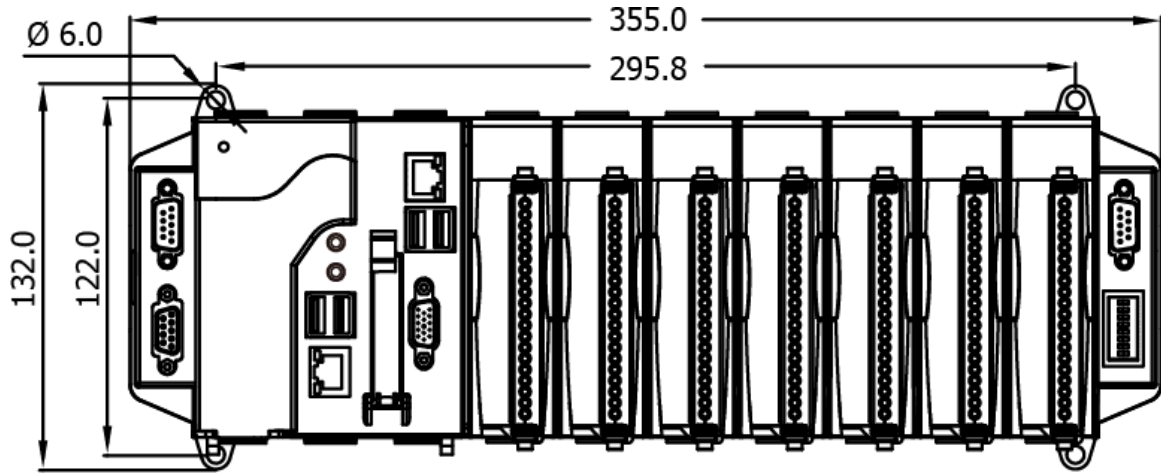

## 1.5. Companion CD

This package comes with a CD that provides a collection of the software utility, documentation, drivers, demo program and application.

For XP-8x31-CE6:

CD:\XP-8X3X-CE6\

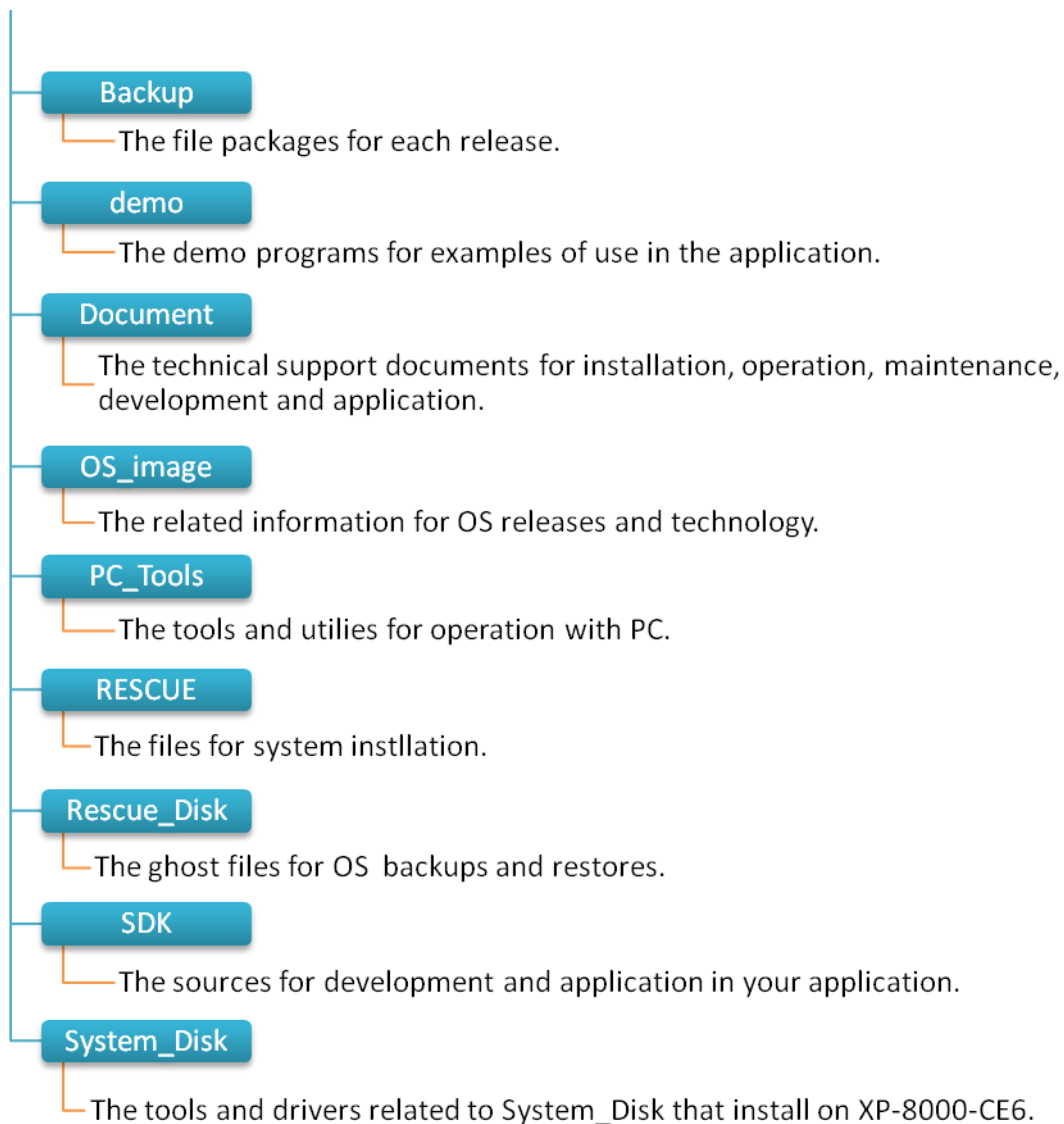

## 2. Getting Started

This chapter provides a guided tour of the XP-8000-CE6 installation and configuration that describes the steps needed to download, install, configure, and run the basic procedures for user working with the XP-8000-CE6 for the first time.

Before starting any task, please check the package contents. If any of the following package contents are missing or damaged, contact your dealer, distributor.



**XP-8000-CE6**



**CF Slot with one CF card**



**Quick Start Guide**



**Software Utility CD**



**Screw Driver (1C016) 2.4 mm**

## 2.1. Mounting the Hardware

Before you work with the XP-8000-CE6, you should have a basic understanding of hardware specification, such as the dimensions, the usable input-voltage range of the power supply, and the type of communication interfaces.

For more information about the hardware details, please refer to “1.2. Specifications”

For more information about the hardware dimensions, please refer to “1.4. Dimension”



### 2.1.1. Mounting the XP-8000-CE6

The XP-8000-CE6 can be mounted either directly to a wall/panel, or onto a standard 35mm DIN rail.

#### Wall/Panel mounting

---

**Step 1:** Install the four mounting screws into the 4 keyhole mounting holes

**Step 2:** Fasten the screws securely

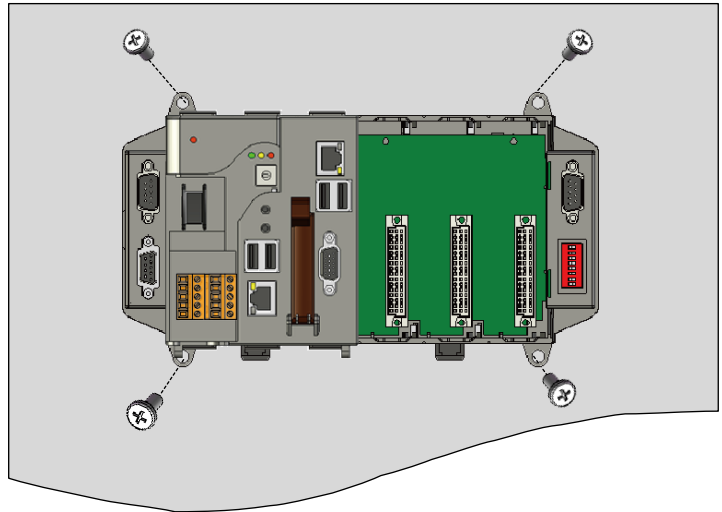

#### Tips & Warnings

---



There must be a minimum clearance of 50mm between the XP-8000-CE6 and the top and bottom side of the enclosure panel.

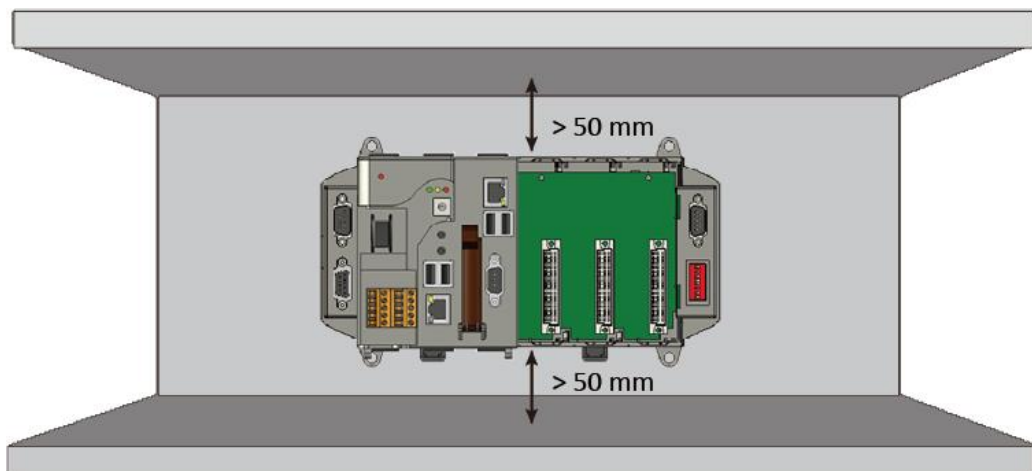

## DIN Rail mounting

---

**Step 1:** Hook upper tab over upper flange of DIN rail

**Step 2:** Tilt the module toward DIN rail until it snaps securely to DIN rail

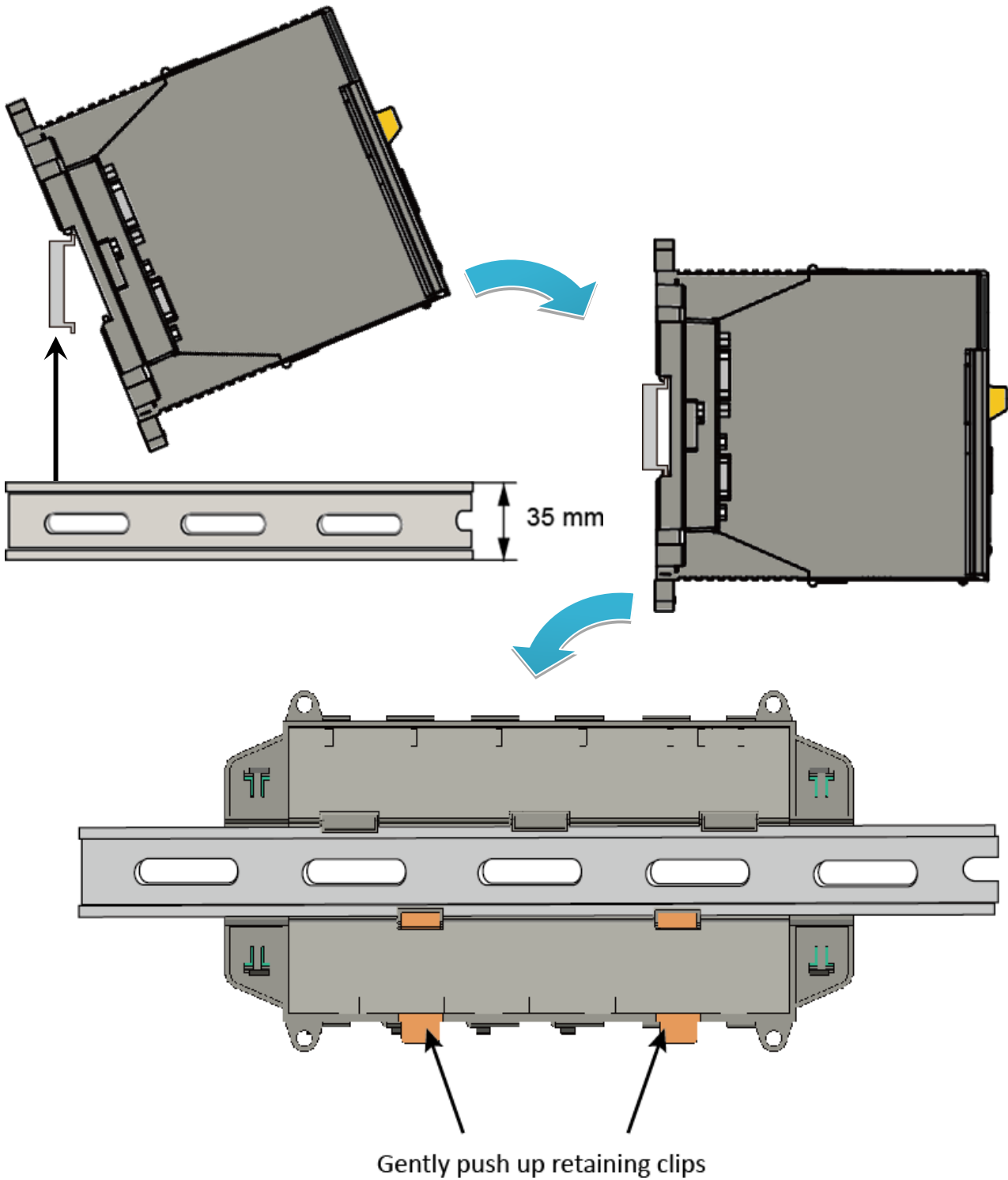

## Tips & Warnings

---



A good common ground reference (earth ground) is essential for proper operation of the XP-8000-CE6. One side of all control circuits, power circuits and the ground lead must be properly connected to earth ground by either installing a ground rod in close proximity to the enclosure or by connecting to the incoming power system ground. There must be a single-point ground (i.e. copper bus bar) for all devices in the enclosure that require an earth ground.

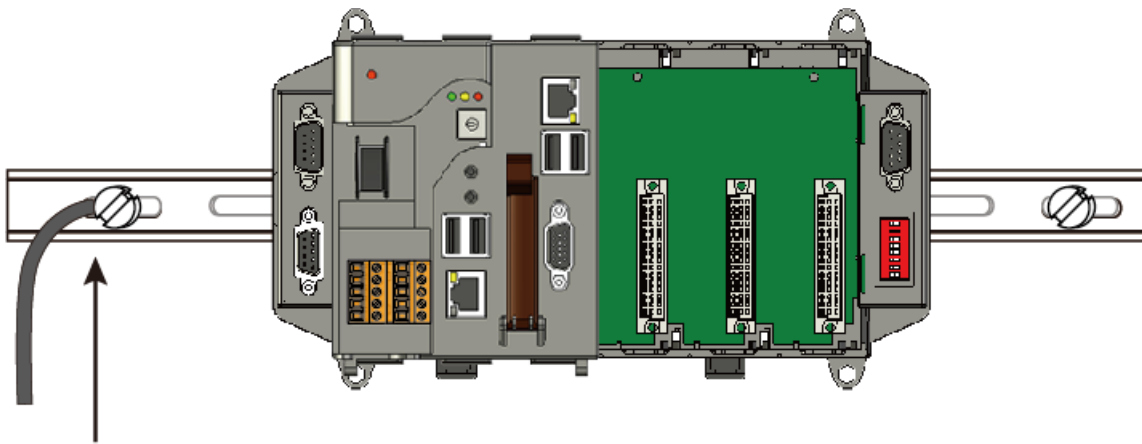

Connect the ground lead to the ground screw

---

## 2.1.2. Deploying a Basic XP-8000-CE6 System

The XP-8000-CE6 provides a variety of communication interface to suit a range of application. Here is a simple application for using the XP-8000-CE6.

**Step 1:** Connect the positive terminal (+) of the power supply to the terminal PWR1/2 and the negative terminal (-) of the power supply to the P.GND

### Tips & Warnings

---



1. The input range of power supply is +10 to +30 V<sub>DC</sub>.
2. The XP-8000-CE6 have two power inputs that can be connected simultaneously to the two independent power sources. If one power source fails, the other source takes over automatically. Redundant power inputs help assure non-stop operation of the XP-8000-CE6.

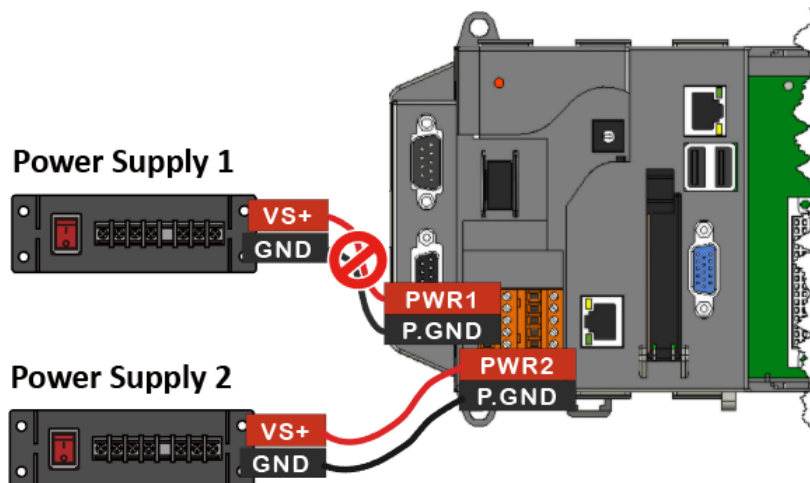

**Step 2:** Connect the USB mouse or the USB keyboard to the USB port

**Step 3:** Connect the monitor to the VGA port

**Step 4:** Connect to PC or the laptop to the LAN port via an Ethernet switch

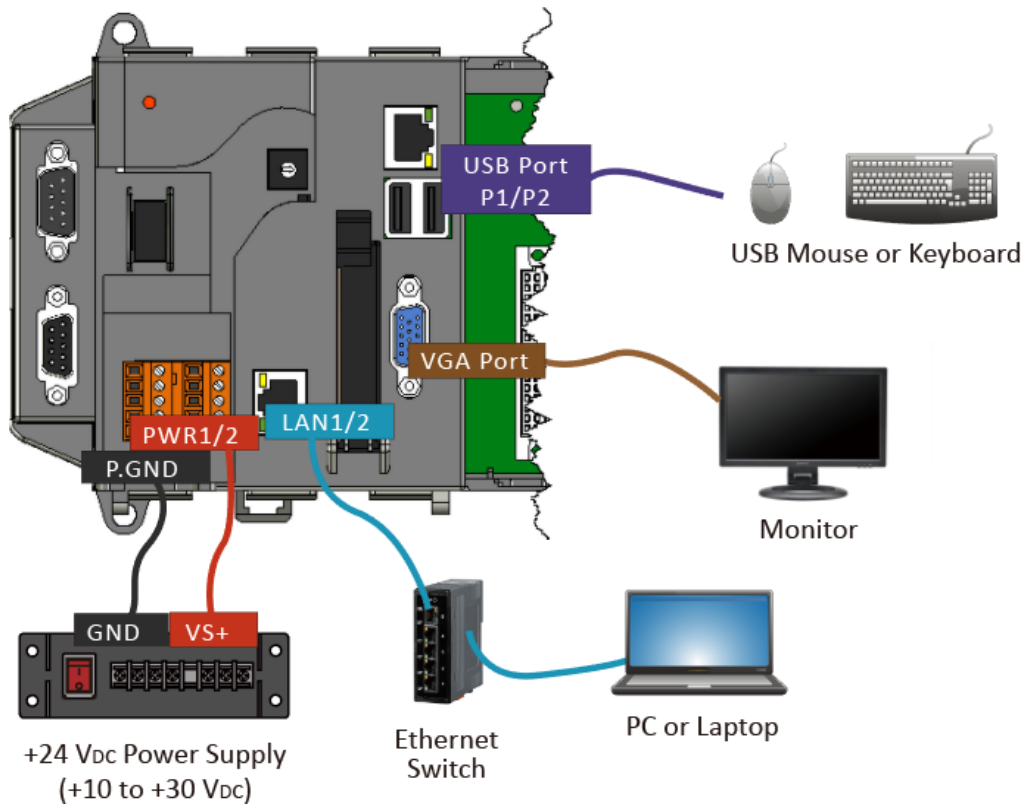

### 2.1.3. Inserting the I/O Modules

XP-8000-CE6 has 0/1/3/7 I/O expansion slot(s) and only supports I-8K and I-87K series I/O modules.

Before choosing the right I/O modules, you first need to know the I/O expansion capacities in order to choose the best expansion module for achieving maximal efficiency. For more information about the I/O expansion modules that are compatible with the XP-8000-CE6, please refer to:

[http://www.icpdas.com/root/product/solutions/remote\\_io/rs-485/i-8k\\_i-87k/i-8k\\_i-87k\\_selection.html](http://www.icpdas.com/root/product/solutions/remote_io/rs-485/i-8k_i-87k/i-8k_i-87k_selection.html)

**Step 1:** Align circuit card with slot and press firmly to seat module into connector

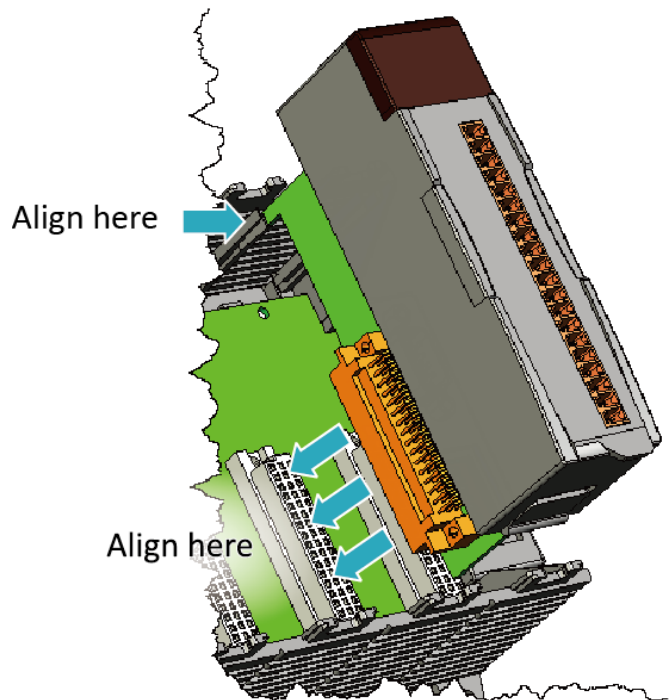

#### Tips & Warnings

---



It is recommended that the power to the XP-8000-CE6 is switched off when wiring the I/O module which are plugging in the XP-8000-CE6 slots.

---

**Step 2:** Pull top and bottom locking tabs toward module face. Click indicates lock is engaged

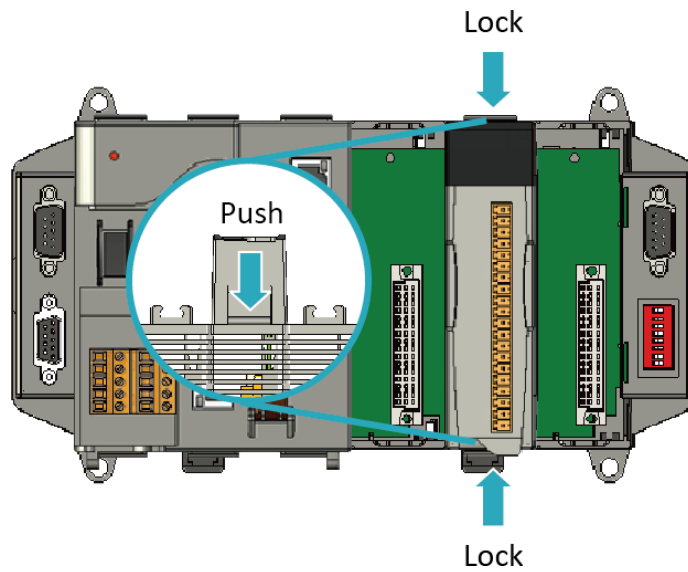

**Step 3:** Attach field wiring using the terminal block, and then insert the terminal block

All I/O Web Page include the I/O module specifications, pin assignments and wiring connections. For example, Pin Assignments and Wiring connections for the I-87054W module are as follows:

[http://www.icpdas.com/root/product/solutions/remote\\_io/rs-485/i-8k\\_i-87k/i-87054w.html](http://www.icpdas.com/root/product/solutions/remote_io/rs-485/i-8k_i-87k/i-87054w.html)

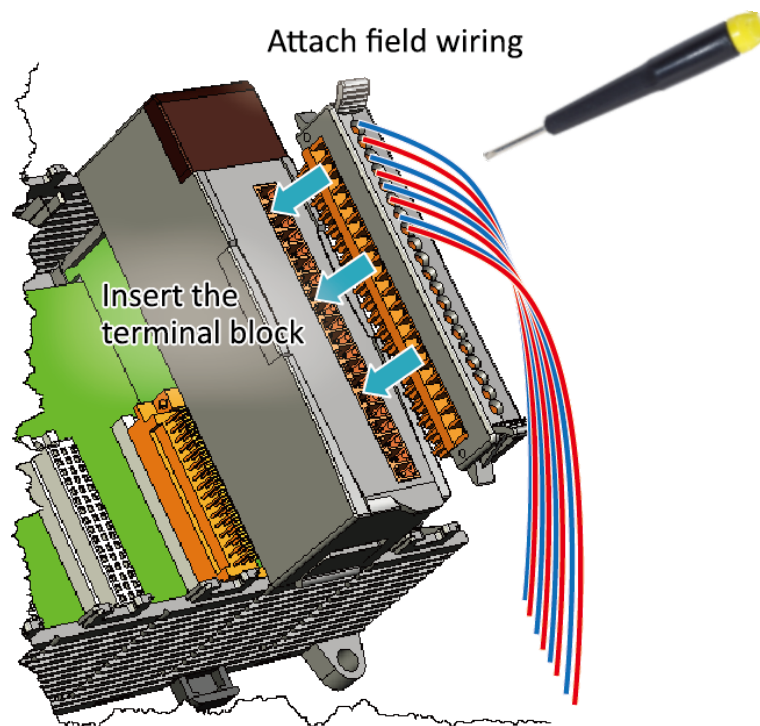

## 2.1.4. Powering up the XP-8000-CE6

The XP-8000-CE6 works with 24 VDC power and provides redundant power inputs with two terminal blocks for PWR1 and PWR2 input.

### Step 1. Wire to power supply

There are two ways to supply power to the XP-8000-CE6.

#### Single power supply

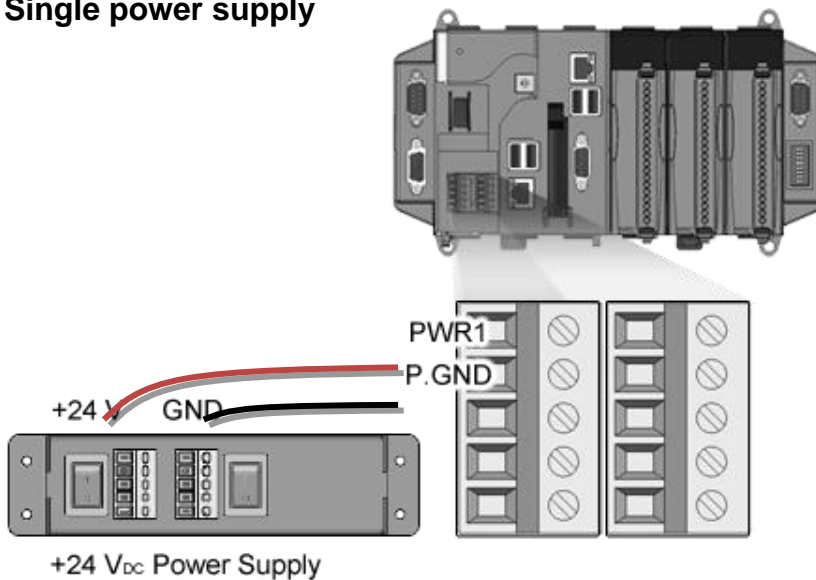

### Tips & Warnings



Once you wire and power up the power supply, confirm the PWR indicator (Red LED) on the CPU module is on.

If the indicator is not on, check the voltage on the terminal block with a voltage meter. If you measure 24 VDC on the terminal block, the CPU module may be defective. Please contact us.



## Redundant power supply

The redundant power can be used single and used two self-governed power to supply to the system, PWR1 and PWR2 input at the same time, when one power fails, the other power acts as a backup, and automatically supplies power needs.

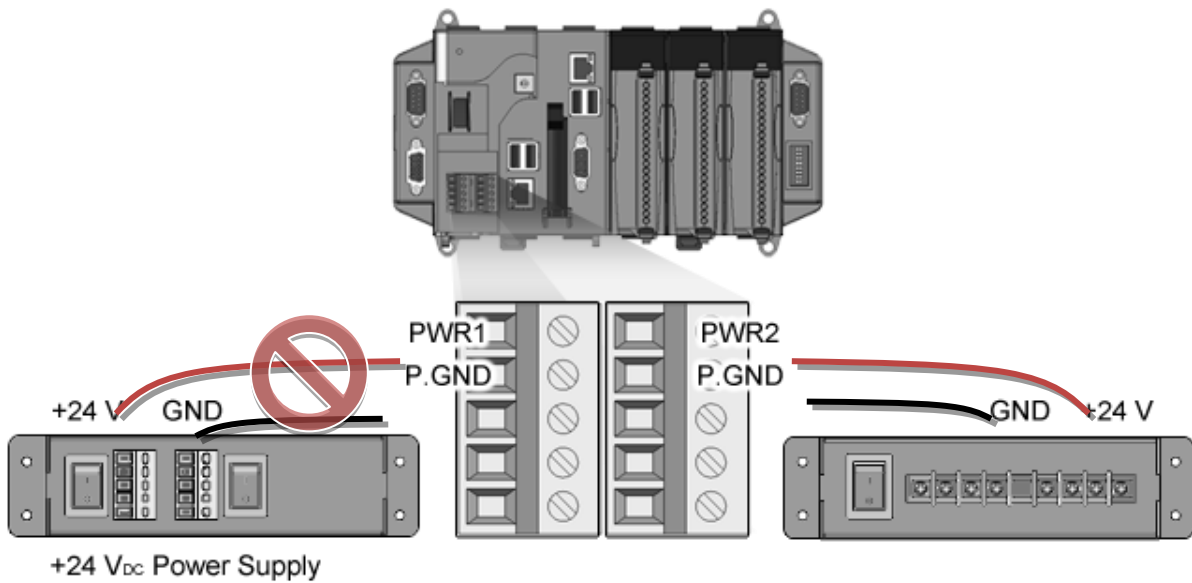

## Step 2. Check the boot status

When powering on the XP-8000-CE6, please note the four LED statuses to make sure the boot is correct. The booting process takes about 40~50 seconds.

---

i. Switch the power switch to the on position

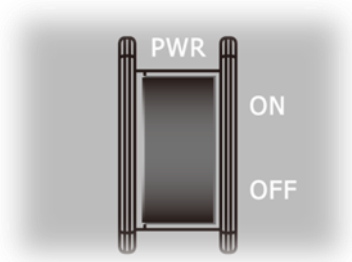

After power on, the LED will be on.



---

ii. Load BIOS

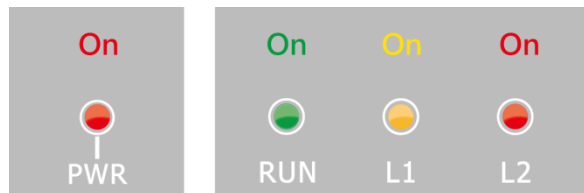

---

iii. Enter the welcome screen

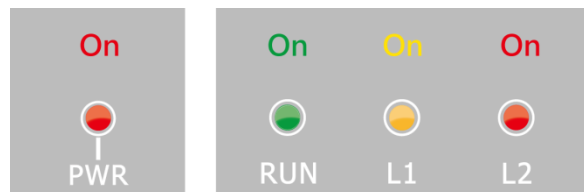

---

iv. Start to load OS



v. OS load successfully

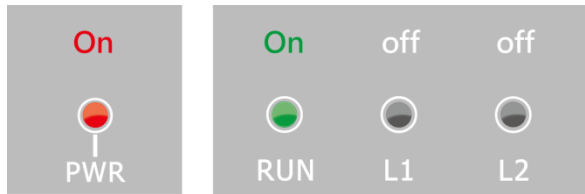

vi. The boot process has been finished successfully.

---

## Tips & Warnings

---



After the boot process has been finished, the L1 and L2 LED indicators will be released. The user can use XPAC API to control them.

The LED light status of XP-8x31-CE6 is different in phase 1 and the status is same in the other phase.

---

## 2.2. Configuring the Boot Mode

The XP-8000-CE6 has several operating modes, which can be selected by a rotary switch.

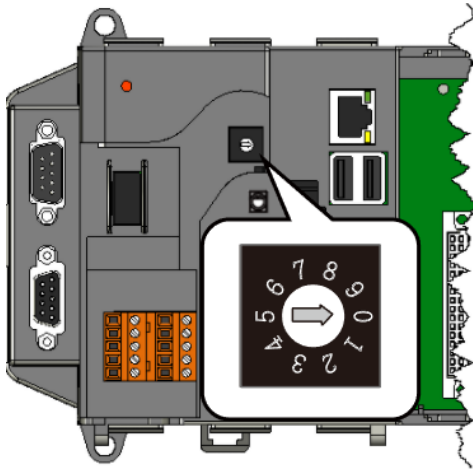

The table below lists the operation modes available with the XP-8000.

| Position | Operating Mode          |
|----------|-------------------------|
| 0        | Normal mode (Default)   |
| 1        | Safe mode               |
| 2        | (For user defined mode) |
| 3        | (For user defined mode) |
| 4        | (For user defined mode) |
| 5        | (For user defined mode) |
| 6        | (For user defined mode) |
| 7        | (For user defined mode) |
| 8        | DCON_CE                 |
| 9        | Remote Display mode     |

The following is a brief introduction of these modes.

### Normal Mode (Default mode)

---

Normal mode is the default mode of operation and the one you will use most of the time. Use this mode for more tasks and configurations. Programs also are executed in this mode.

## Safe Mode

---

Safe mode is a troubleshooting mode. The mode loads the minimum required device drivers and system services to boot the XP-8000-CE6.

If you have malicious software or a program caused the XP-8000-CE6 cannot be boot or run the normal mode, you can boot in safe mode to solve the problem.

## DCON\_CE

---

In this mode, the DCON\_CE will be run automatically, and other settings are same as the normal mode.

For more information about the DCON CE, please refer to section 3.3. DCON CE.

## Remote Display

---

In this mode, the cerdisp.exe will be run automatically, and other settings are same as the normal mode.

For more information about the Remote Display, please refer to section 2.5. Using Remote Display to Control the XP-8000-CE6 Remotely.

## User Mode

---

The positions 2~7 of rotary switch are reserved for user's applications.

When XP-8000-CE6 is boot with one of these positions, it is boot at normal mode. User's application can check the position of the rotary switch position to run at different mode.

## 2.3. Changing the User Interface Language

The **Regional and Language Settings** is a Windows CE functionality that allows users to change the XP-8000-CE6 user interface with your native language.

**Step 1:** Click Start menu, point to Settings, click Control Panel, and then click Regional Settings

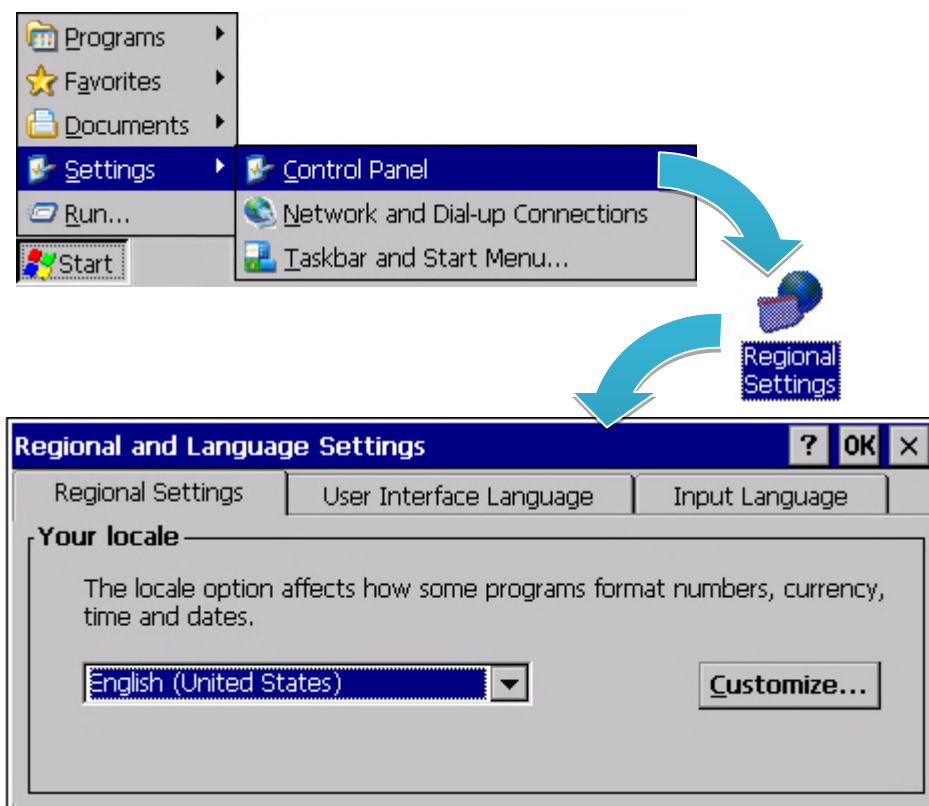

**Step 2:** Click User Interface Language tab, choose to your local language, and then click OK button



**Step 3:** Double-click the XPAC Utility on the desktop, and then reboot the XP-8000-CE6 for changes to take effect

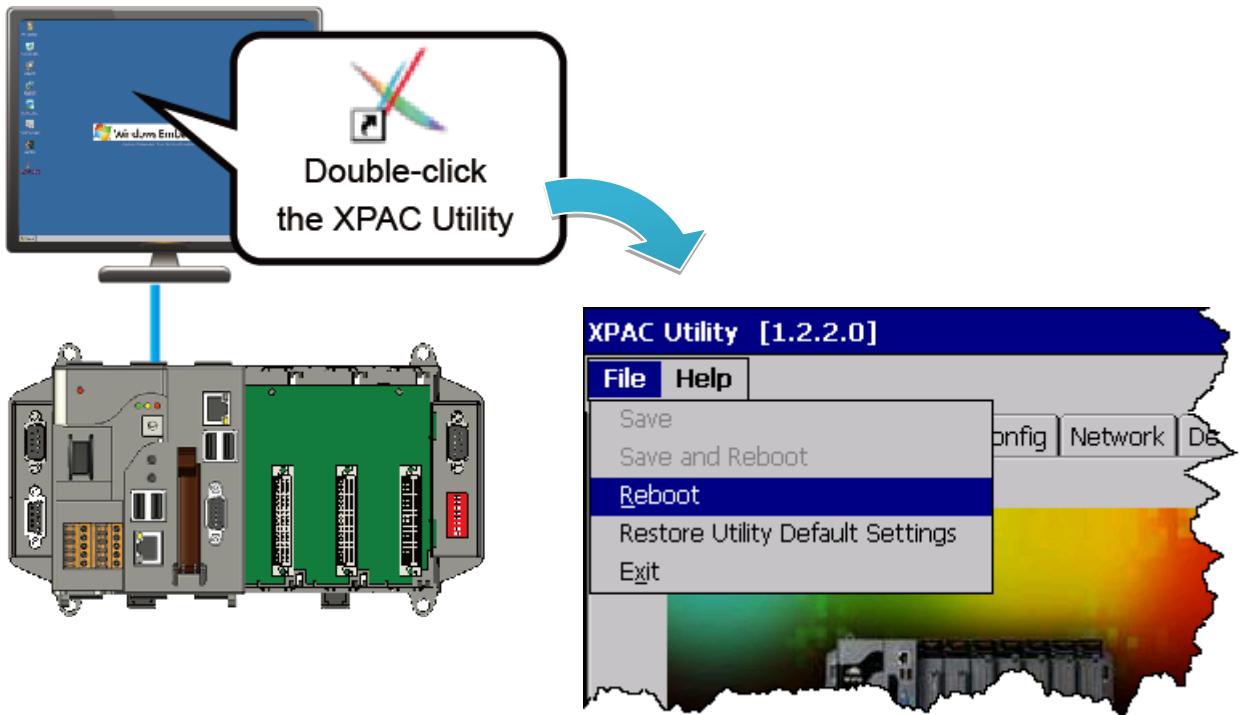

## 2.4. Using XPAC Utility to Manage the XP-8000

The XPAC Utility is a collection of the XP-8000-CE6 system tool that allows users to manage and configure the XP-8000-CE6 quickly and easily.

For more detailed information on XPAC Utility applications, please refer to “3.1. XPAC Utility”

**Step 1:** Double-click the XPAC Utility on the desktop

**Step 2:** Configure IP address (DHCP), FTP Server, Auto Execution files, etc.

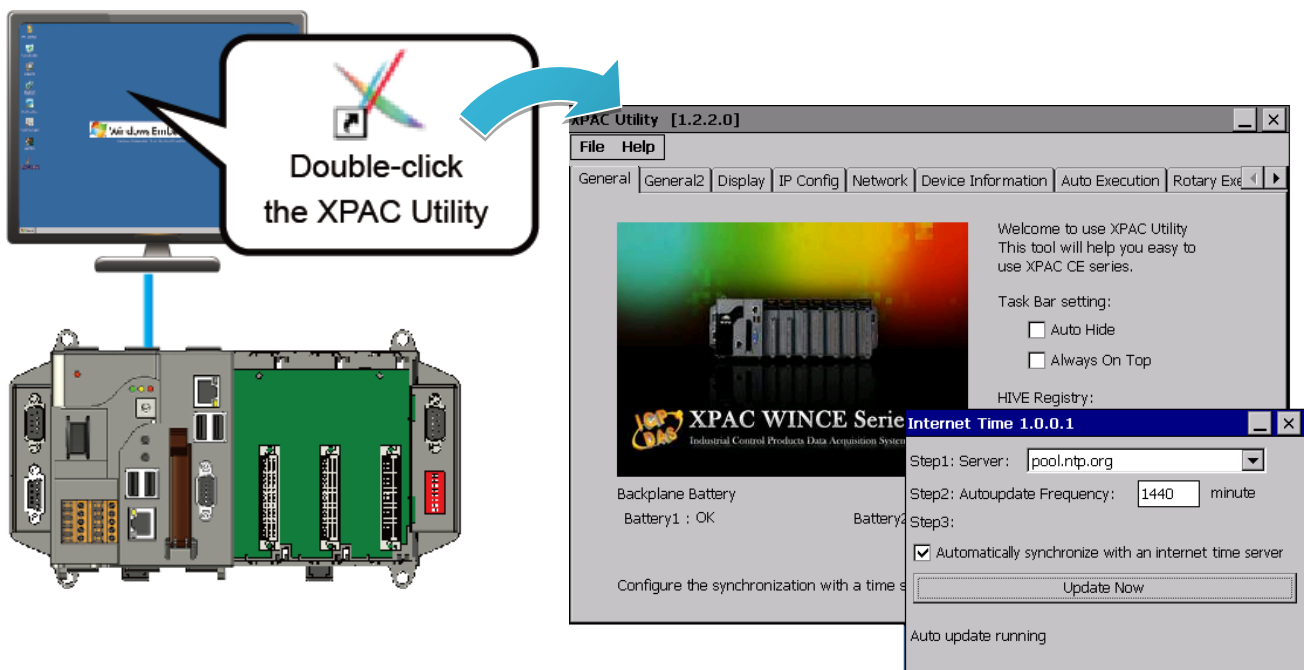

**Step 3:** Reboot the XP-8000-CE6 for changes to take effect

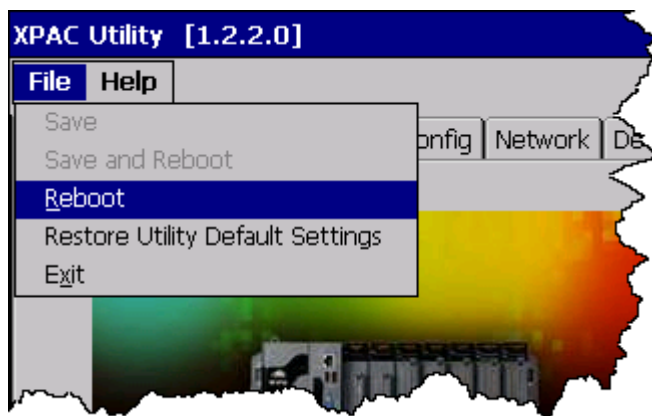



## 2.5. Using Remote Display to Control the XP-8000-CE6 Remotely

The "Remote Display" is a Windows CE functionality that allows XP-8000-CE6 to be controlled and monitored from a remote location. This tool is composed of two parts, a client and a server. The server is a program named cerdisp.exe running on XP-8000-CE6. The client is a PC-based program named cerhost.exe running on the PC.

Here are step by step instructions on how to use Remote Display to control XP-8000-CE6 remotely.

### Step 1. On PC side, click client program, cerhost.exe

The Remote Display can be installed from the CD or by downloading the latest version from ICP DAS web site.

CD:\XP-8000-CE6\PC\_Tools\Remote\_Display\

[ftp://ftp.icpdas.com/pub/cd/xp-8x3x-ce6/pc\\_tools/remote\\_display/](ftp://ftp.icpdas.com/pub/cd/xp-8x3x-ce6/pc_tools/remote_display/)



### Step 2. On XPAC side, click server program, cerdisp.exe

The cerdisp.exe are pre-installed on the XP-8000-CE6, located under  
\System\_Disk\Tools\Remote\_Display

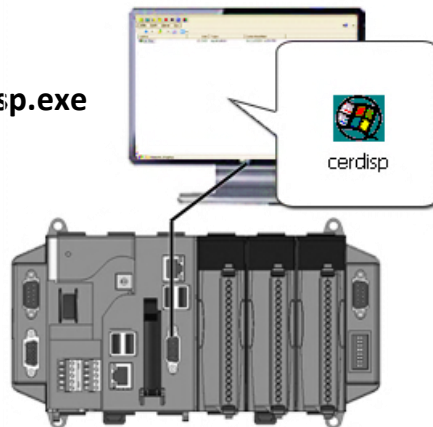

**Step 3. Click OK button, click Connect button, type the IP address of the host PC**

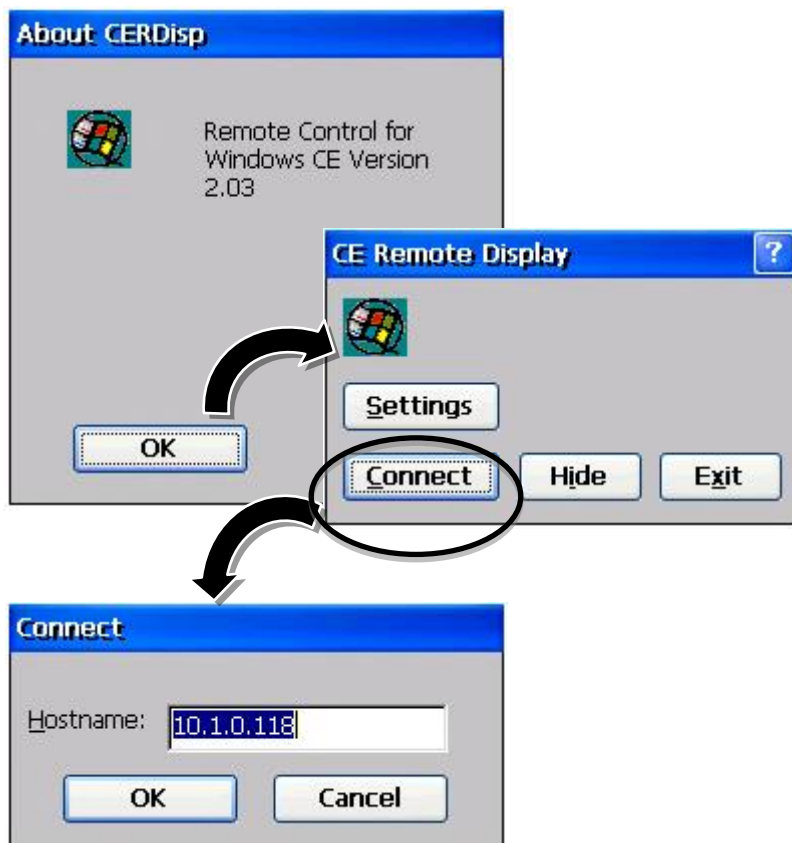

**Step 4. The remote connection has been established**

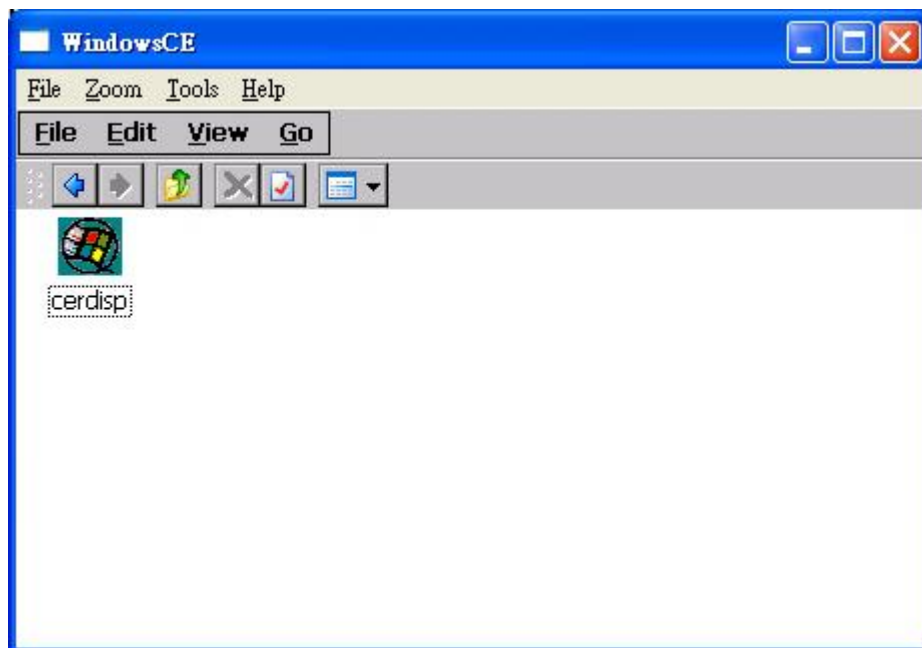

## 2.6. Using DCON Utility Pro Configure I/O Modules

DCON Utility Pro allows users to configure and manage the I/O modules via Ethernet or serial ports (RS-232/RS-485).

**Step 1: Double-click the DCON\_Utility\_Pro on the desktop**

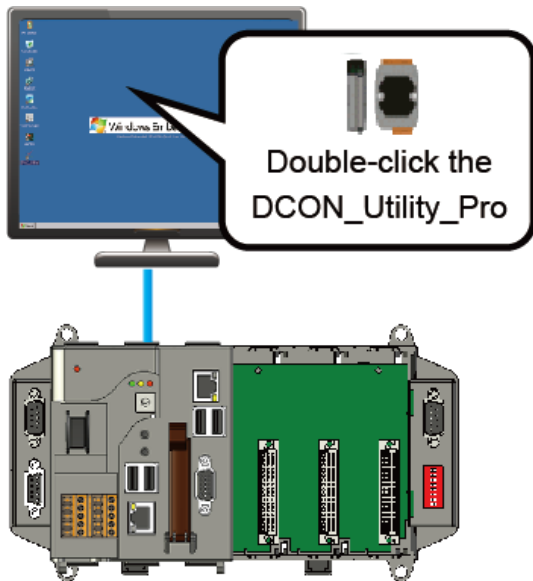

**Step 2: Click the  button**

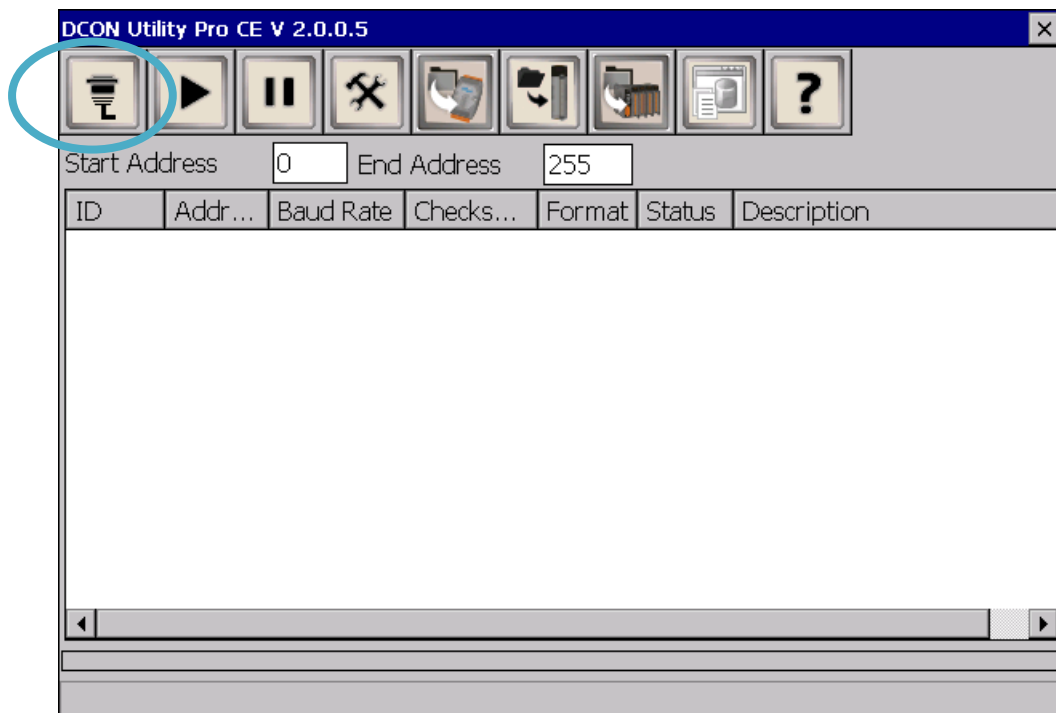

### Step 3: Configure the communication settings

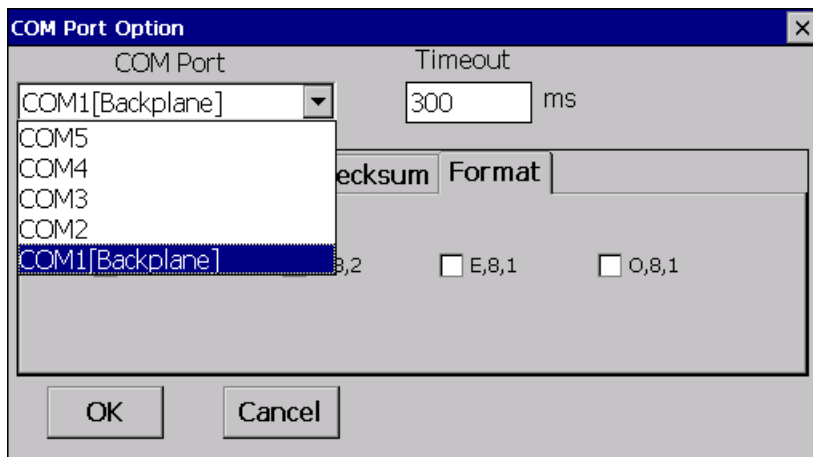

#### Tips & Warnings



The COM port settings for expansion I/O modules are listed below.

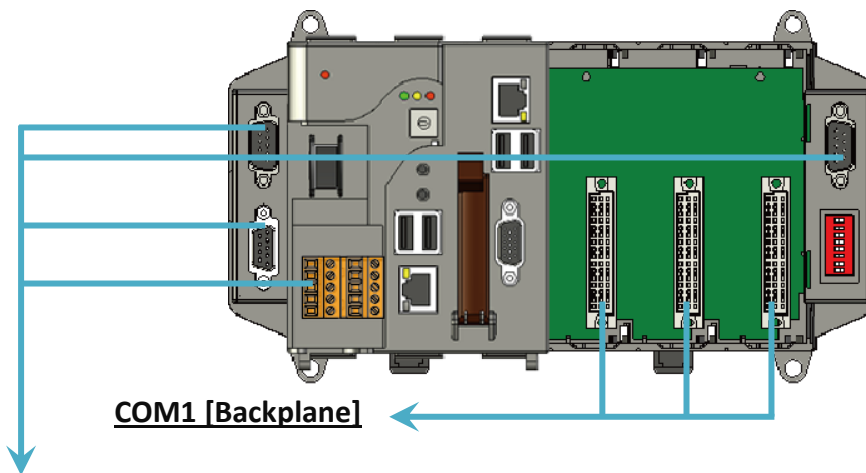

#### COM 2/3/4/5

For more information on these COM port selections, please refer to the specification of the pin assignments in section 1.3. Overview

Step 4: Click the  button to scan the I/O module

Step 5: Click the module name to configure the I/O module

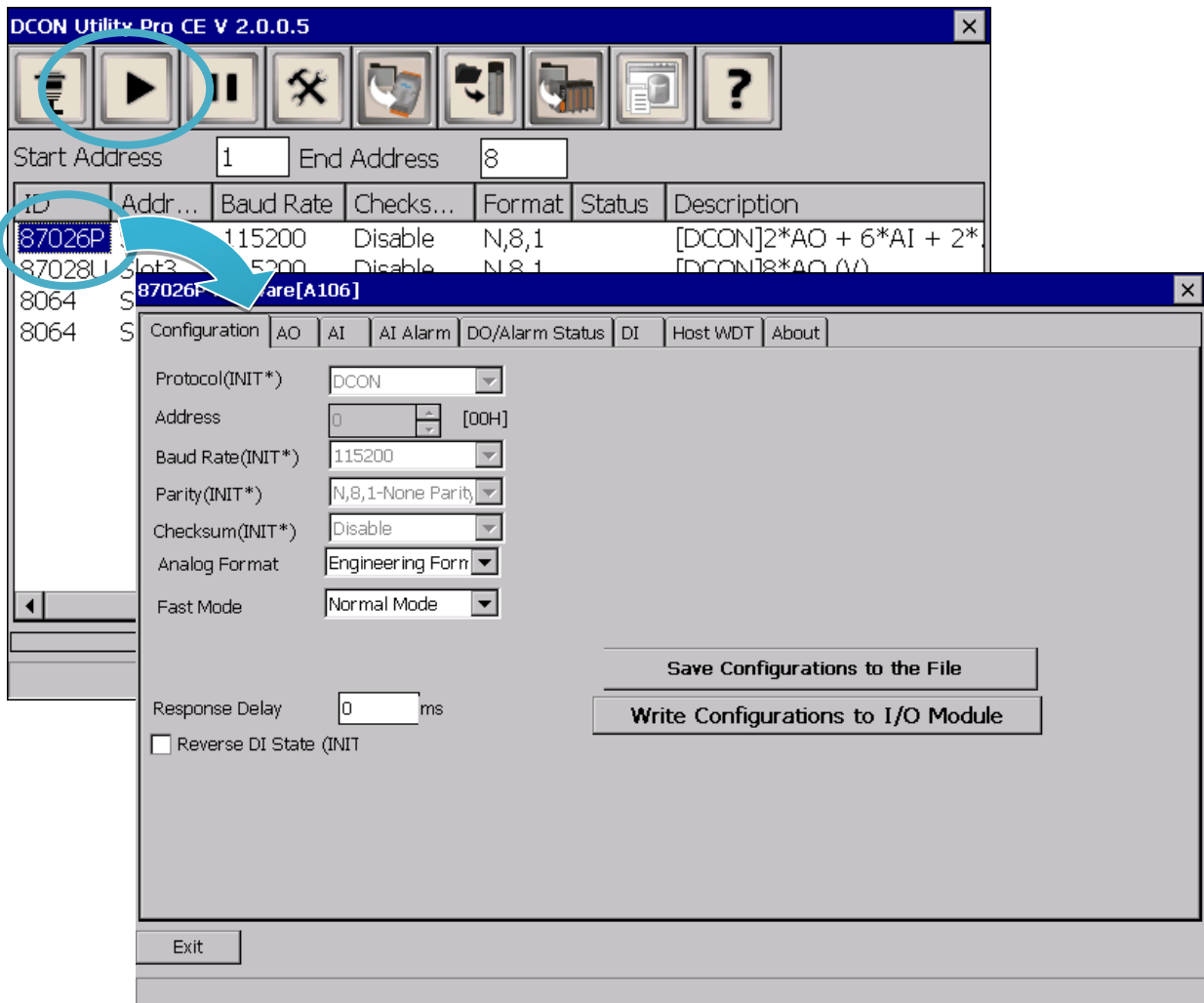

## 2.7. Using DCON\_CE to Remote Configure the I/O Module

The DCON Utility is a client utility that runs on PC, and communicates with XP-8000-CE6 via DCON protocol. The DCON Utility allows users to remotely connect to I-7K and I-87K series I/O modules for management through the COM port and Ethernet port.

This tool is composed of two parts, a client and a server. The server is a program named DCON\_CE\_XP running on XP-8000-CE6. The client is a PC-based program named DCON Utility running on the PC.

Here are step by step instructions on how to use DCON Utility to configure the I/O modules.

### Step 1. On XPAC side, click server program, DCON\_CE

The DCON\_CE\_XP are pre-installed on the XP-8000-CE6, located under  
\\System\_Disk\\Tools\\DCON\_CE

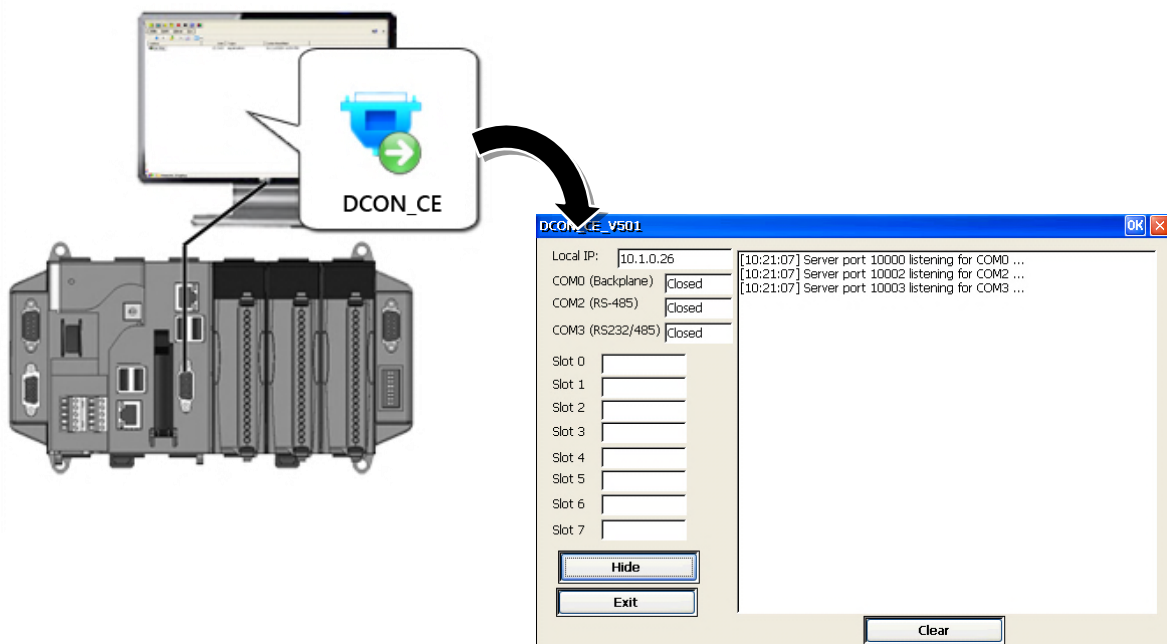

## Step 2. On PC side, Run the DCON Utility

The DCON Utility can be installed from the CD that was provided with the package or by downloading the latest version from ICP DAS web site.

CD:\XP-8000-CE6\PC\_Tools\DCON\_Utility\

[ftp://ftp.icpdas.com/pub/cd/xp-8x3x-ce6/pc\\_tools/dcon\\_utility/](ftp://ftp.icpdas.com/pub/cd/xp-8x3x-ce6/pc_tools/dcon_utility/)

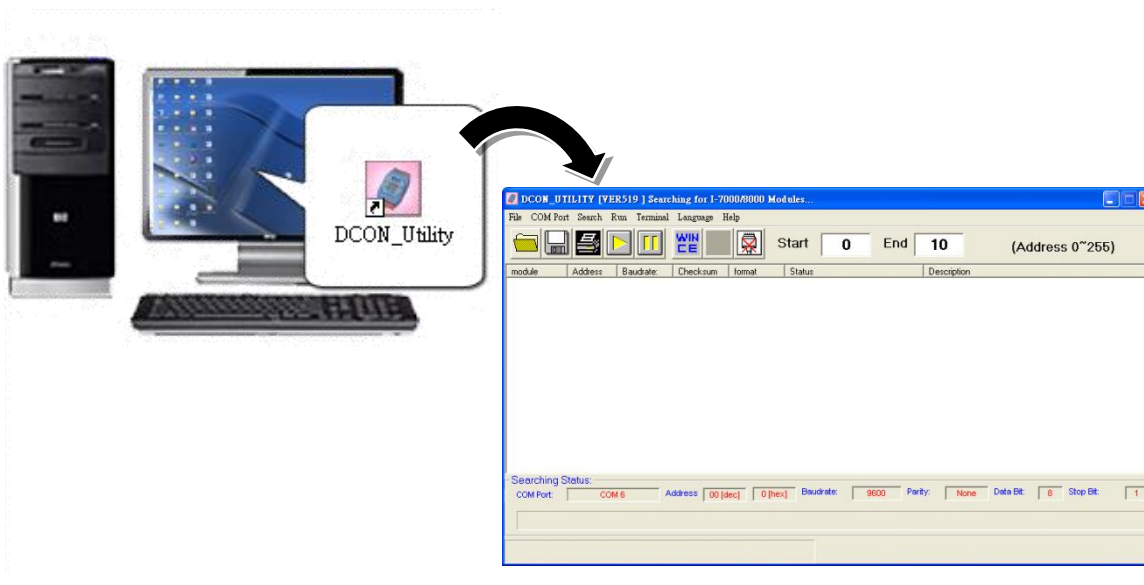

## Step 3. Click WINCE common button

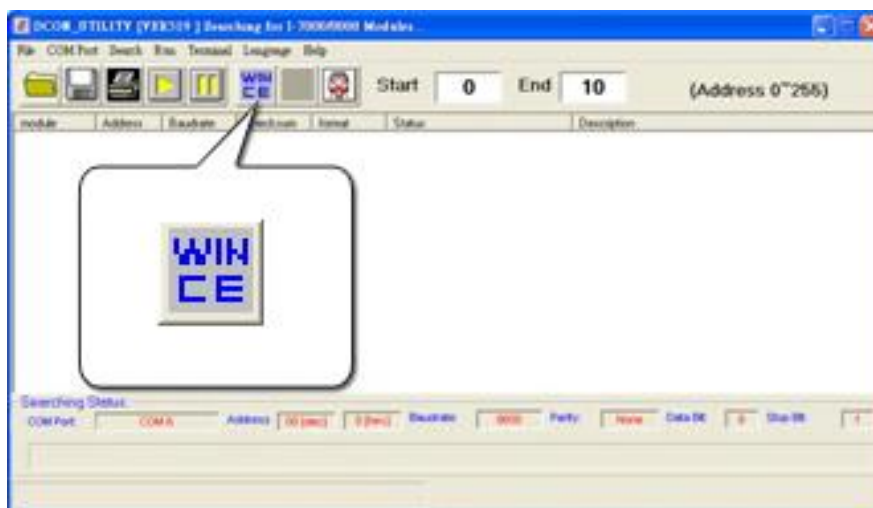

Step 4. Click XPAC\_CE tab, type the IP address of the XPAC, and then click Connect to XPAC\_CE button

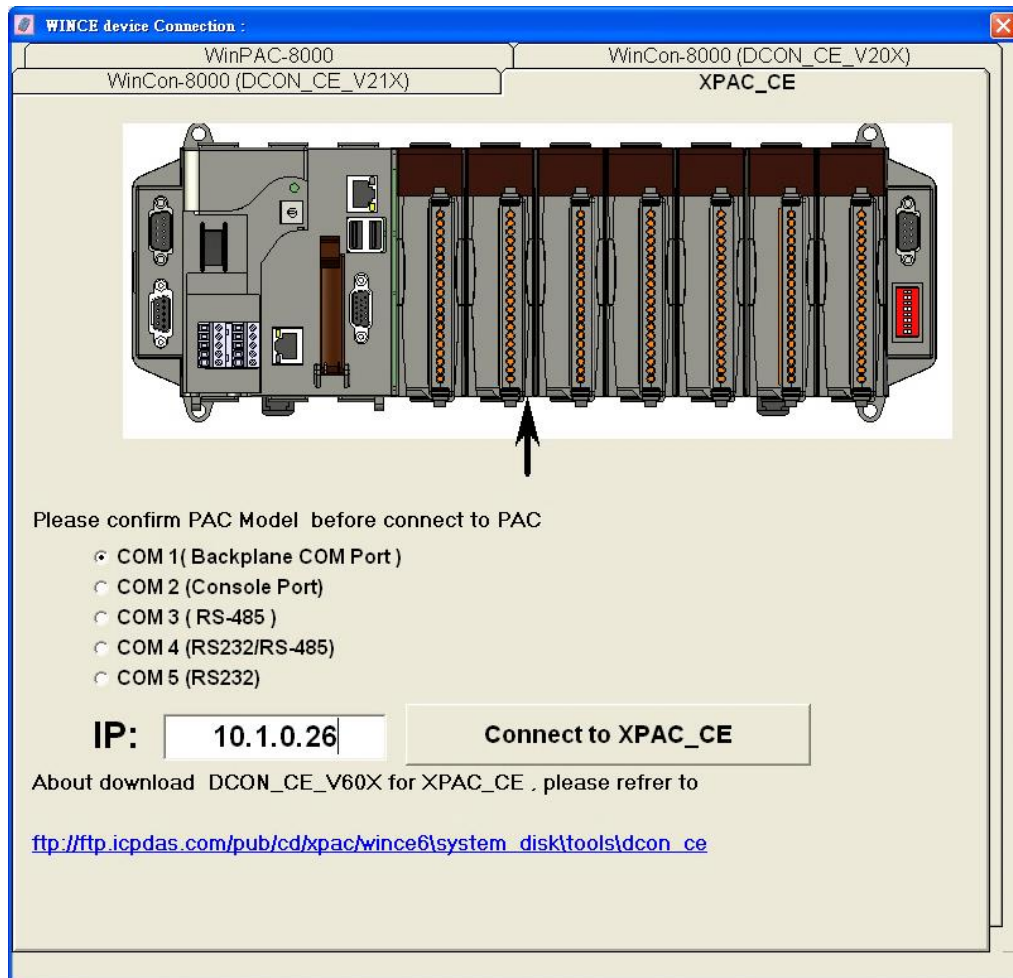

## Tips & Warnings



If DCON Utility cannot connect to XP-8000-CE6, the Ethernet connection between Host PC and XP-8000-CE6 might be rejected by fire wall, please contact with MIS to open the Ethernet port.



Step 5. Click on the module name from the list to configure the settings form

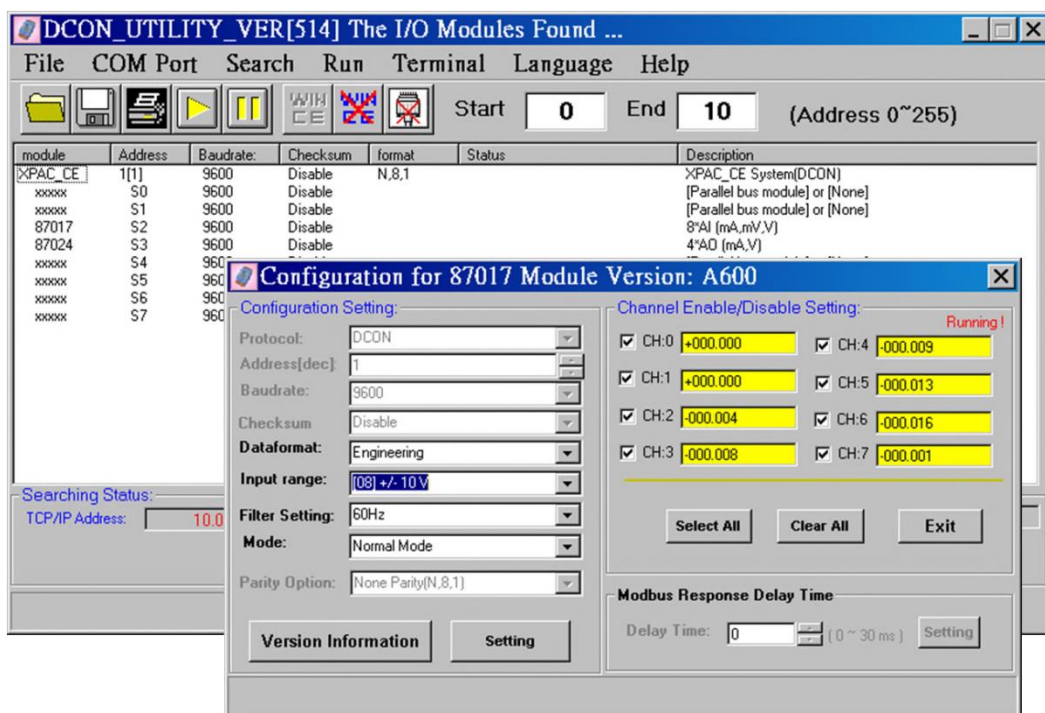

## Tips & Warnings



If there is no operation within 30 seconds, the connection will automatically close to release the COM port occupied.



### 3. Tools and Tasks

This chapter provides a brief introduction of the XP-8000-CE6 service tools and its benefits.

There are several tools and utilities built-in and designed for use with XP-80006. Some of these are pre-installed on XP-8000-CE6 and can work directly on XP-8000, and some of these are supporting tools and can help you to manage the XP-8000-CE6 remotely on a PC.

The following tools are pre-installed on XP-8000-CE6 and can work directly on XP-8000-CE6 that can be found on the CD that was provided with the package or by downloading the latest version from ICP DAS web site.

- For XP-8x31-CE6:

CD:\XP-8X3X-CE6\System\_Disk\Tools\

[http://ftp.icpdas.com/pub/cd/xp-8x3x-ce6/system\\_disk/tools/](http://ftp.icpdas.com/pub/cd/xp-8x3x-ce6/system_disk/tools/)

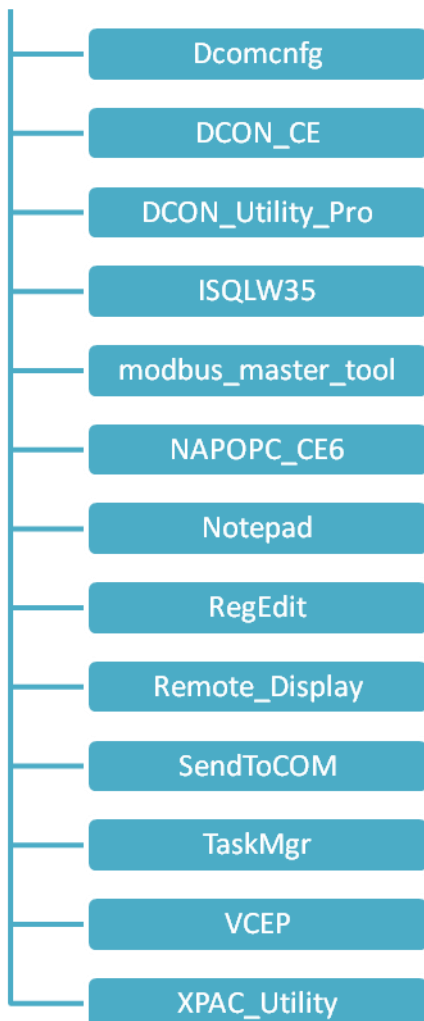

### 3.1. XPAC Utility

XPAC Utility is a collection of software applications that enable management and configuration of XP-8000-CE6 system and features.

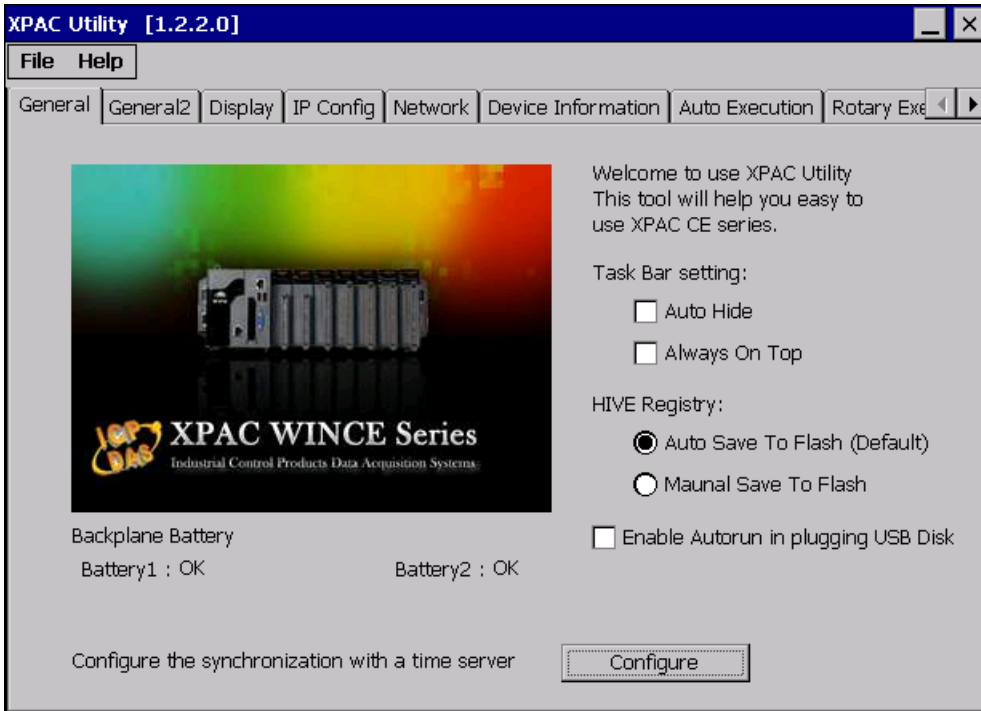

The XPAC Utility includes the following menu bars and property tabs. All of these functions will be explained later.

| Menu bar | Property Tab            |
|----------|-------------------------|
| File     | General                 |
| Help     | General2                |
|          | Display                 |
|          | IP Config               |
|          | Network                 |
|          | Device Information      |
|          | Auto Execution          |
|          | Rotary Execution        |
|          | Multi-IO Module         |
|          | Backplane Compatibility |

### 3.1.1. Menu Bar – File

By default, the available default items are shown to the right.

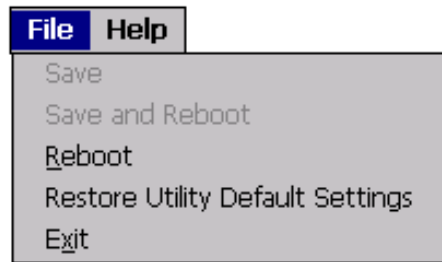

All menu items will be enabled when the **Manual Save To Flash** option is selected.

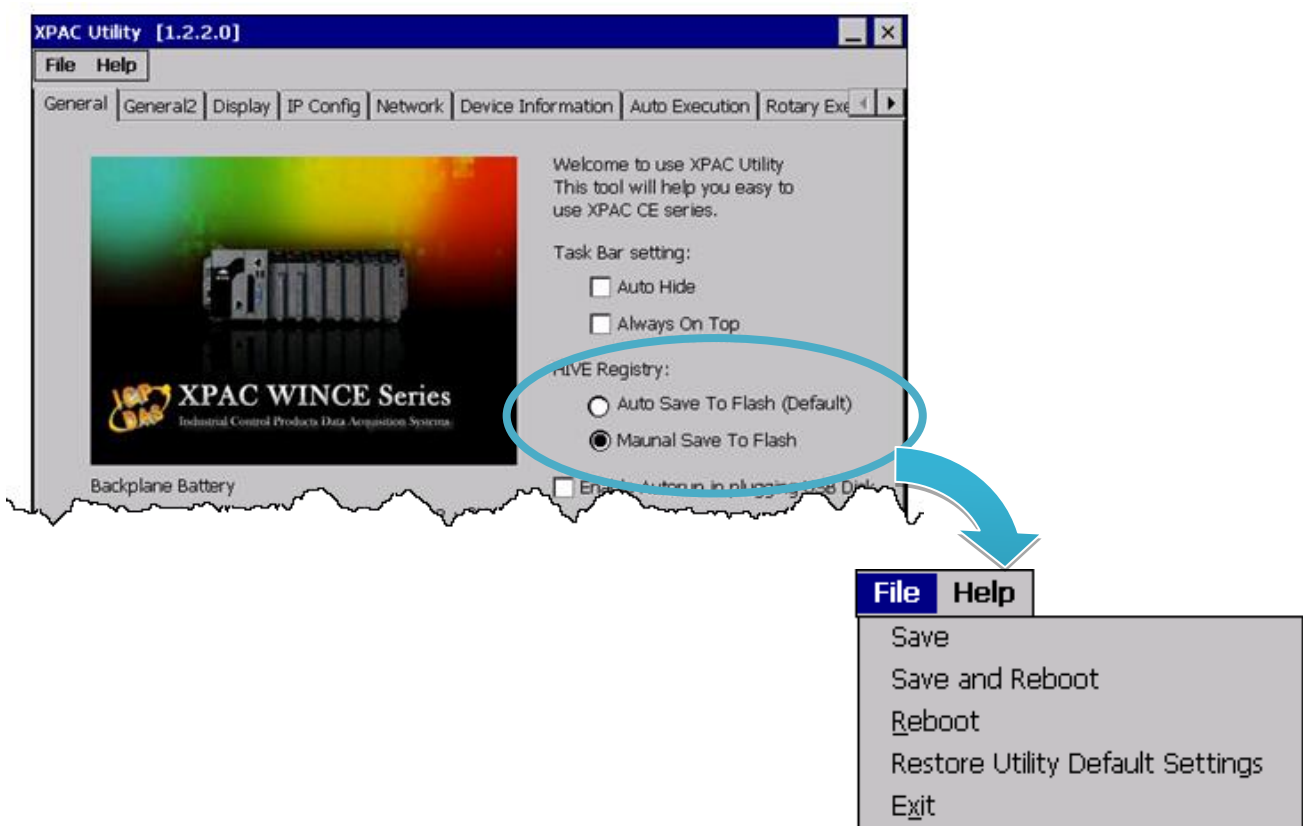

| The menus use to                 | How to use   |
|----------------------------------|--|
| Save                             | By default, this item is disabled until the <b>Manual Save To Flash</b> option is selected. Saves the changes.                             |
| Save and Reboot                  | By default, this item is disabled until the <b>Manual Save To Flash</b> option is selected. Saves the changes and reboots the XP-8000-CE6. |
| Reboot                           | Restarts the XP-8000-CE6.  |
| Restore Utility Default Settings | Restore the XP-8000-CE6 to default settings.   |
| Exit                             | Exits the XPAC Utility.  |

### 3.1.2. Menu Bar – Help

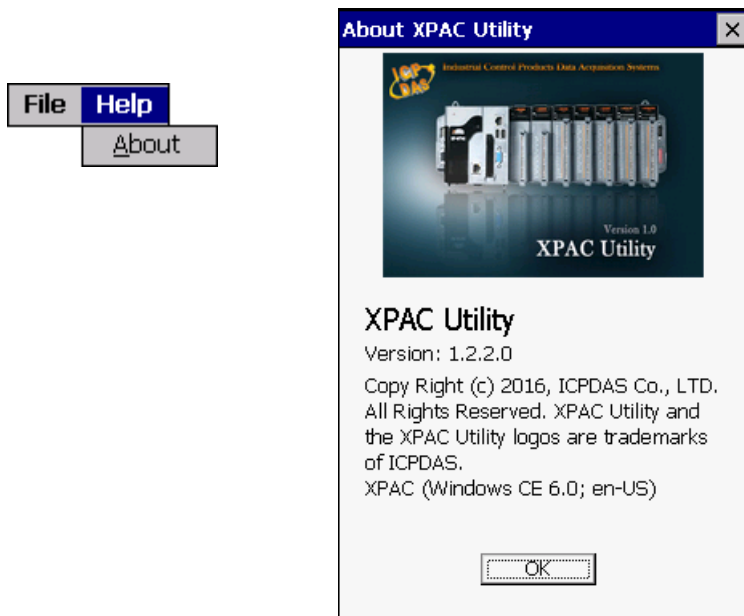

| The menus use to | How to use  |
|------------------|---|
| About            | Displays a dialog box with information about XPAC Utility, including the current version and copyright information. |

### 3.1.3. Property Tab - General

The **General** tab provides functions to configure the task bar, check the status of the battery..., etc.

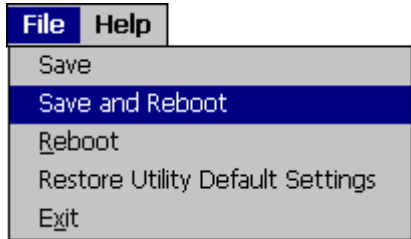

| The tab use to                    | How to use   |
|-----------------------------------|--|
| Lock or Auto-Hide the taskbar     | <p><b>Auto-Hide the taskbar:</b><br/>Select the <b>Auto Hide</b> check box.</p> <p><b>Lock the taskbar:</b><br/>Select the <b>Always On Top</b> check box.</p>   |
| Auto save or manual save to flash | <p><b>Auto save to flash:</b><br/>Select the <b>Auto Save To Flash (Default)</b> check box.<br/>Any changes made to the XP-8000-CE6 will be saved and only take effect after the XP-8000-CE6 reboots.</p> <p><b>Manual save to flash:</b><br/>Select the <b>Manual Save to Flash</b> check box.<br/>Any changes made to the XP-8000-CE6 will be saved by clicking the Save and Reboot from File menu.</p>  |

| The tab use to                                     | How to use   |
|--|--|
| Enable USB autorun                                 | Click to check the check box for <b>Enable Autorun in plugging USB Disk</b> .  |
| Monitor the information of battery 1 and battery 2 | See the Battery1 and Battery2 field that displays the battery status.  |
| Automatic synchronization of system time           | Refer to the Appendix A.2. How to configure the service for automatically synchronizing with the internet time server. |

### 3.1.4. Property Tab – General2

The **General2** tab provides functions to specify the name of the USB disk.



| The tab use to                   | How to use   |
|----------------------------------|--|
| Specify the name of the USB disk | Enter a name in the <b>USB Hard Disk:</b> field, and then click the <b>Set</b> button. |



### 3.1.5. Property Tab – Display

The **Display** tab provides functions to configure the monitor settings.

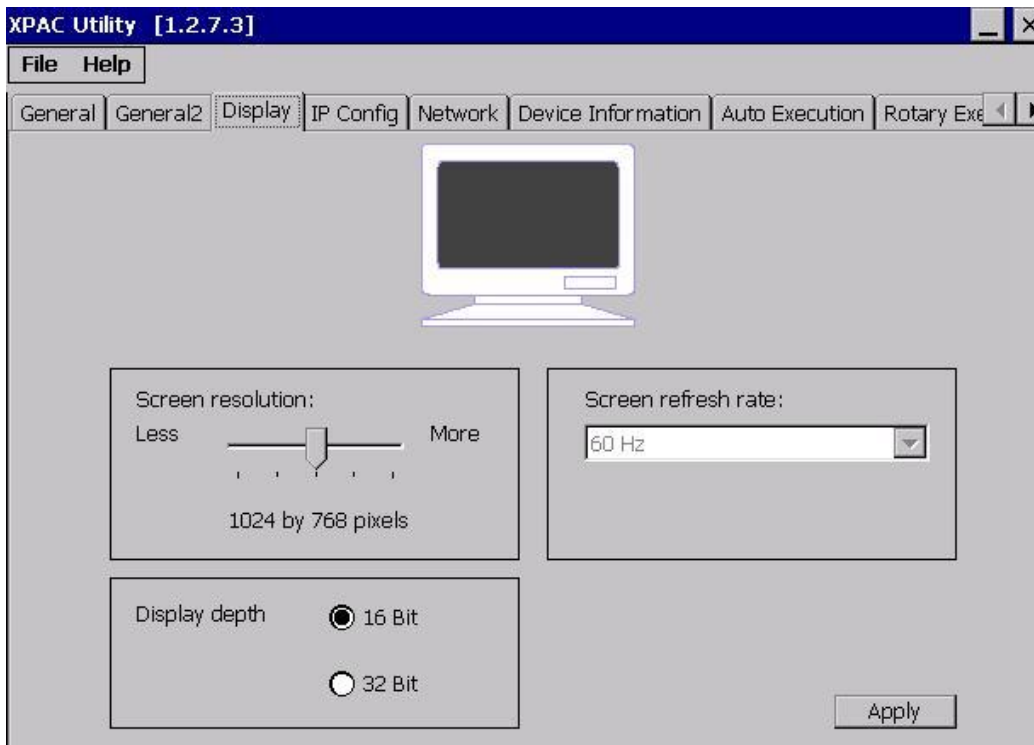

| The tab use to                 | How to use   |
|--------------------------------|--|
| Adjust the screen resolution   | Move the slider to the left to decrease the resolution or move the slider to the right to increase the resolution, and then click the <b>Apply</b> button. |
| Change the screen refresh rate | Select the desired refresh rate from the <b>Screen refresh rate</b> drop-down list, and then click the <b>Apply</b> button.                                |
| Display depth                  | Select the “16 bit” or “32 bit” to setting the display depth, and then click the <b>Apply</b> button.<br>The display depth default setting is “16 bit”.    |

### 3.1.6. Property Tab – IP Config

The **IP Config** tab provides functions to configure either DHCP (Roaming) or manually configured (Static) network settings and to monitor the MAC address. Generally, DHCP is the default settings, but if you don't have a DHCP server, you must configure the network settings by using manual configuration.

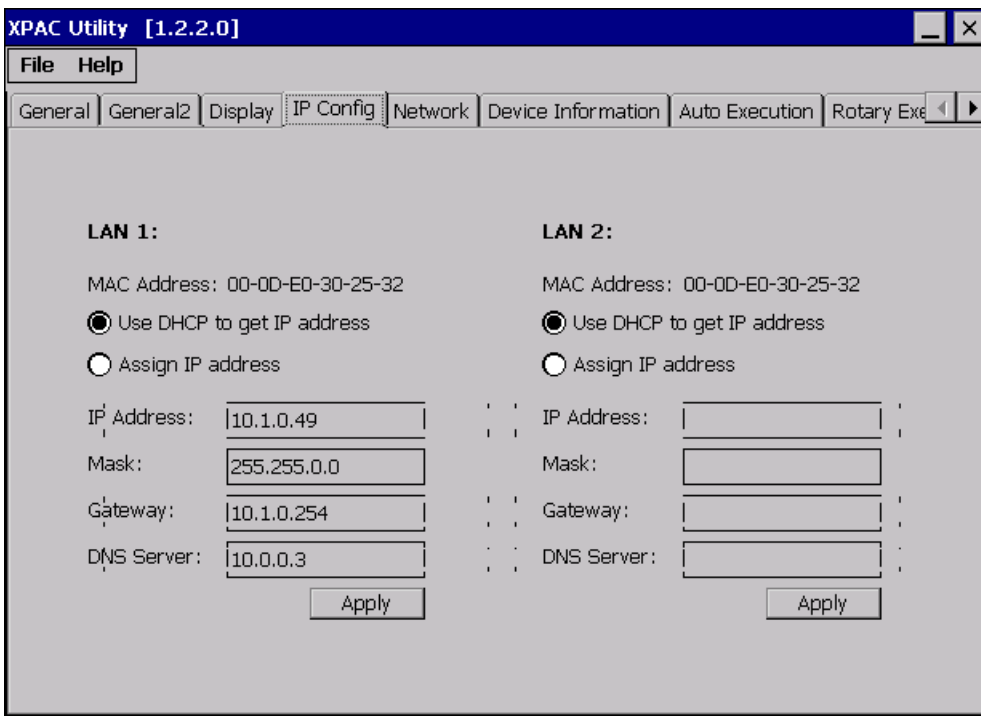

| The tab use to           | How to use   |
|--------------------------|--|
| Set the network settings | <p><b>Use DHCP to get IP address:</b><br/>Select the <b>Use DHCP to get IP address</b> option, and then click the <b>Apply</b> button.</p> <p><b>Assign an IP address:</b><br/>Select the <b>Assign IP address</b> option, and then click the <b>Apply</b> button.</p> |

### 3.1.7. Property Tab – Network

The **Network** tab comprises three tabs – Access, Login and File Server Settings.

#### Access

The **Access** tab provides functions to enable/disable the FTP access, enable/disable anonymous FTP access, and configure the FTP and HTTP directory path.

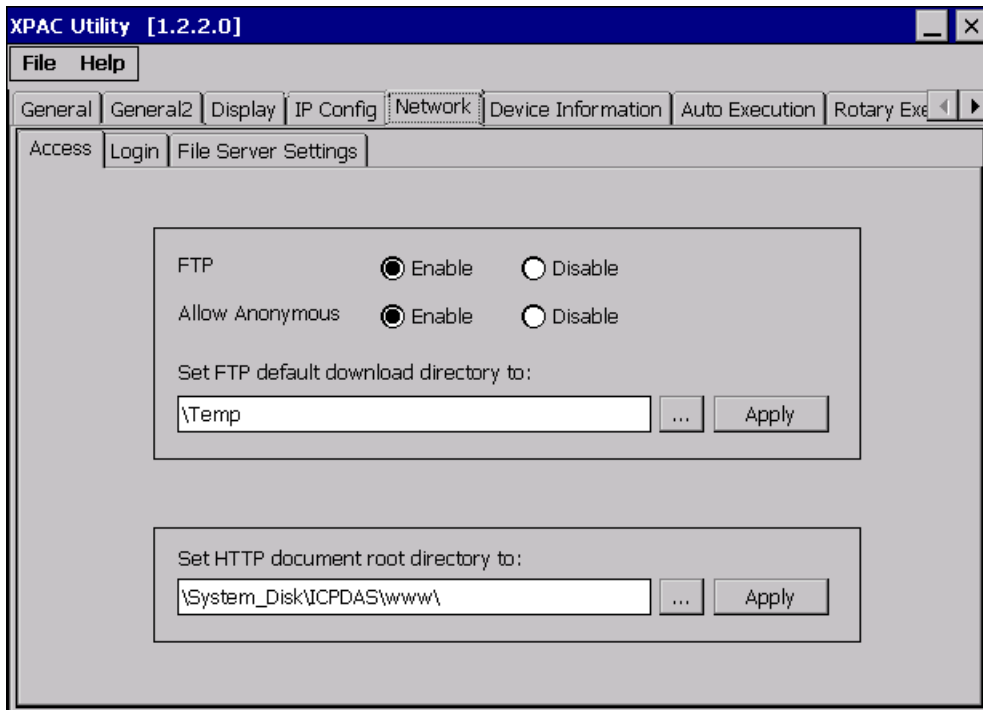

| The tab use to                   | How to use  |
|----------------------------------|---|
| Enable or disable the FTP access | <p><b>Enable the FTP access:</b><br/>Select the <b>Enable</b> check box in the <b>FTP</b> field, and then click the <b>Apply</b> button.</p> <p><b>Disable the FTP access:</b><br/>Select the <b>Disable</b> check box in the <b>FTP</b> field, and then click the <b>Apply</b> button.</p> |

| The tab use to                         | How to use  |
|--|---|
| Enable or disable anonymous FTP access | <p><b>Enable anonymous FTP access:</b><br/>Select the <b>Enable</b> check box in the <b>Allow Anonymous</b> field, and then click the <b>Apply</b> button.</p> <p><b>Disable anonymous FTP access:</b><br/>Select the <b>Disable</b> check box in the <b>Allow Anonymous</b> field, and then click the <b>Apply</b> button.</p> |
| Set the FTP directory path             | Enter a new path in the <b>Set FTP default download directory to:</b> field, and then click the <b>Apply</b> button.  |
| Set the HTTP directory path            | Enter a new path in the <b>Set HTTP document root directory to:</b> field, and then click the <b>Apply</b> button.  |

## Login

The **Login** tab provides functions to maintain the FTP accounts.

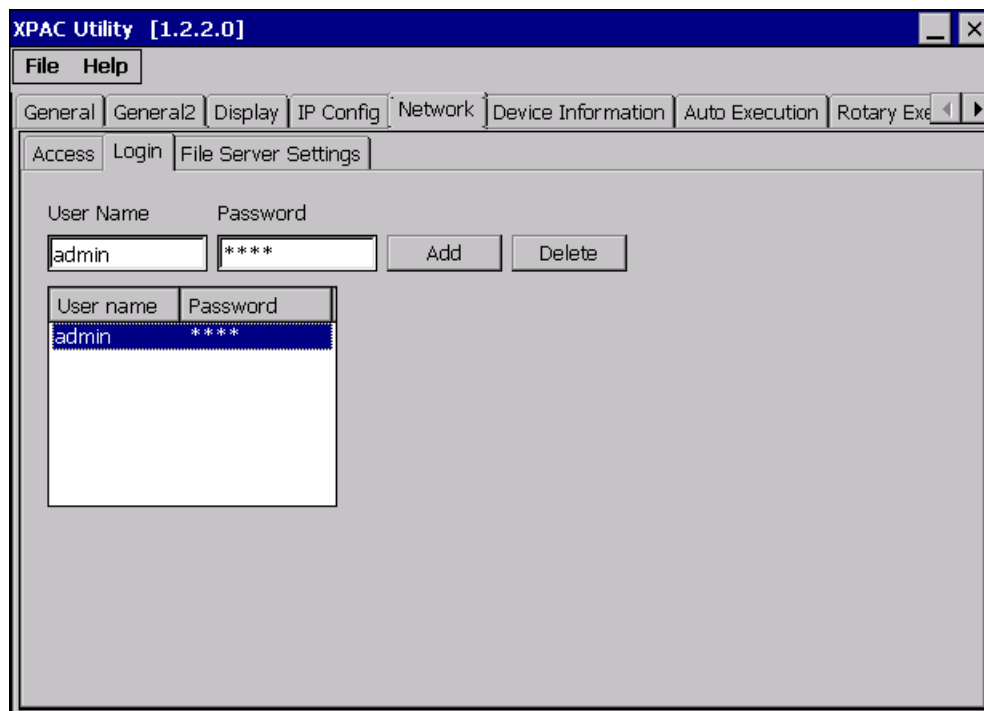

| The tab use to            | How to use   |
|---------------------------|--|
| Maintain the FTP accounts | Refer to the Appendix D.1 How to add a user account to remote login the XP-8000-CE6 from PC. |

## File Server Settings

The **File Server Settings** tab provides functions to set the SMB server.

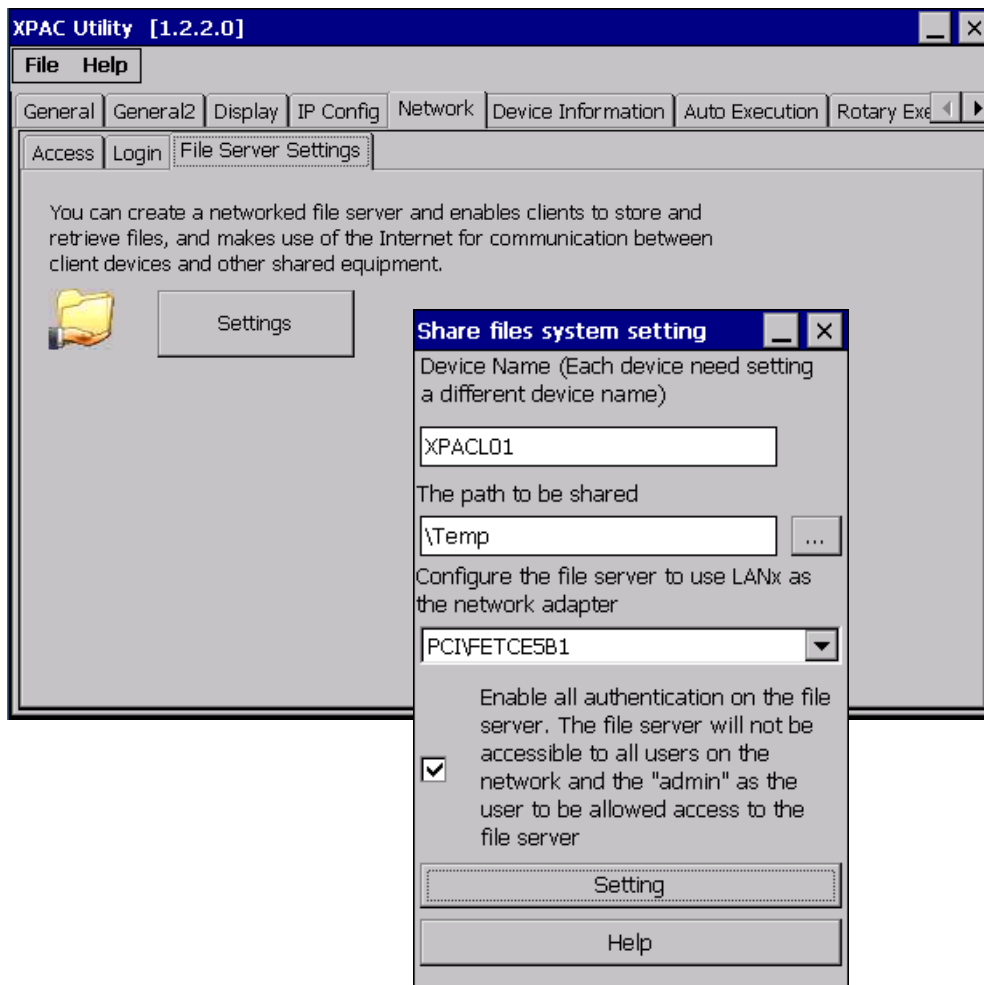

### The tab use to

### How to use

Set the SMB server

Click the Settings button to set the SMB server path.

### 3.1.8. Property Tab – Device Information

The **Device Information** tab provides functions to monitor necessary system information of the XP-8000. The information is the most important note of version control for upgrading system.

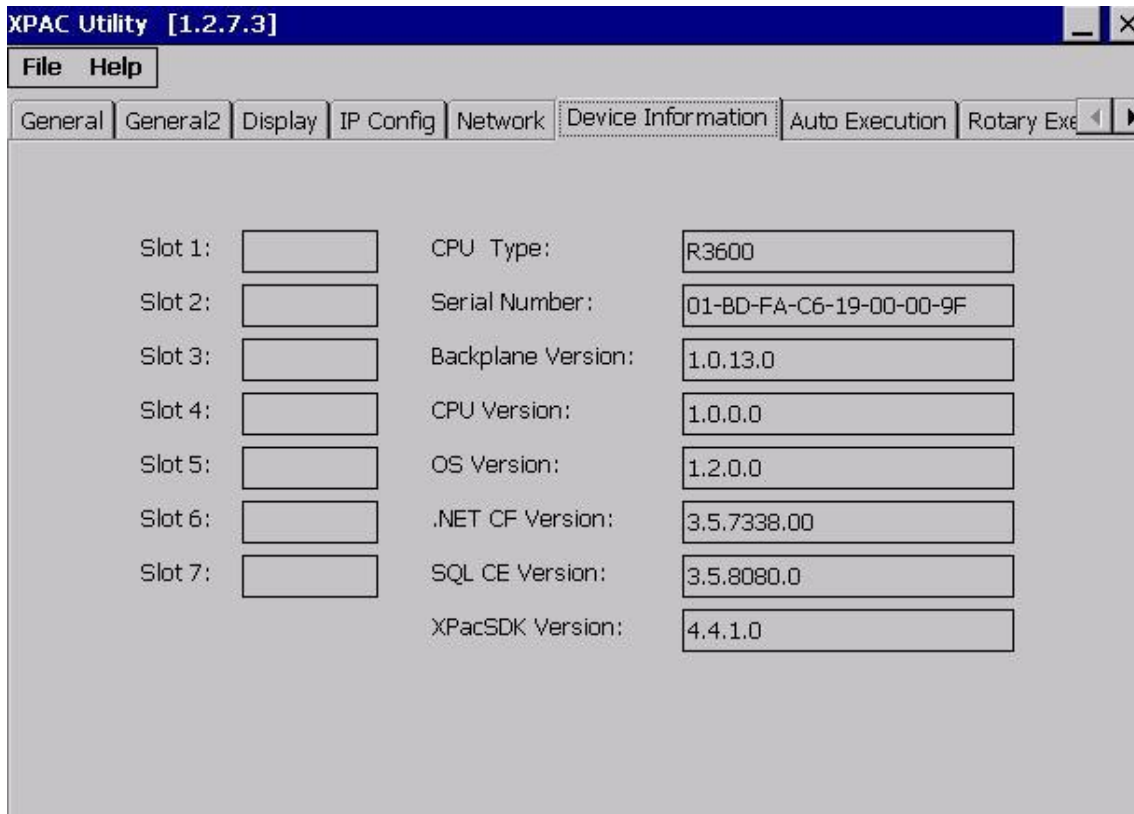

### 3.1.9. Property Tab – Auto Execution

The **Auto Execution** tab provides functions to configure programs running at XP-8000-CE6 startup, it allows users to configure ten execute files at most.

#### Tips & Warnings



The specific extensions are .exe and .bat, and they are executed in order of program 1, program 2, etc.

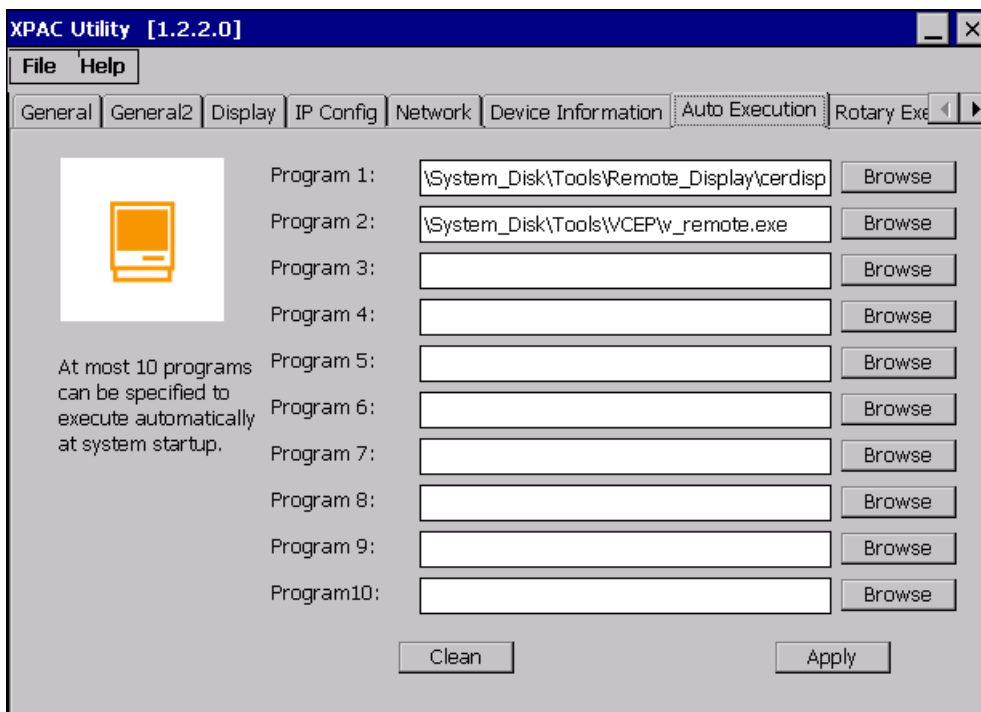

#### The tab use to

Configure programs running at startup

#### How to use

Click the **Browse** button to select the execute file which you want, and then click the **Apply** button.

### 3.1.10. Property Tab – Rotary Execution

The Rotary Execution tab provides function to decide which mode XP-8000-CE6 executes at startup.

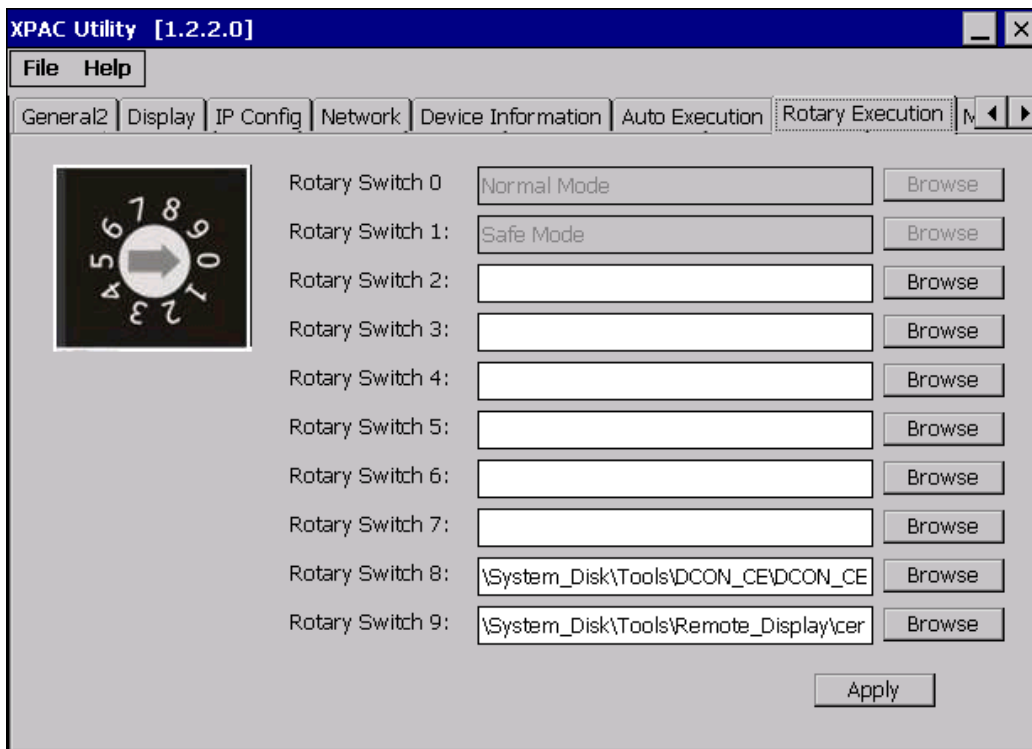

| The tab use to   | How to use   |
|--|--|
| Start XP-8000-CE6 in normal mode   | Turn the rotary switch in position 0 and reboot the XP-8000-CE6. By default, this item is disabled.  |
| Start XP-8000-CE6 in safe mode   | Turn the rotary switch in position 1 and reboot the XP-8000-CE6. By default, this item is disabled.  |
| Start XP-8000-CE6 in normal mode and auto execute the user-specified program | Click the <b>Browse</b> button to select the execute file which you want, click the <b>Apply</b> button, and then turn the rotary switch in position 2/3/4/5/6/7 and reboot the XP-8000-CE6. |
| Start XP-8000-CE6 in normal mode and auto execute the DCON CE utility        | Turn the rotary switch in position 8 and reboot the XP-8000-CE6. By default, this item is disabled.  |
| Start XP-8000-CE6 in normal mode and auto execute the Remote Display server  | Turn the rotary switch in position 9 and reboot the XP-8000-CE6. By default, this item is disabled.  |



### 3.1.11. Property Tab – Multi-IO Modules

The Multi-serial port provides functions for installation of the RS-232/RS-422/RS-485 communication module driver.

The table below shows the expansion RS-232/RS-422/RS-485 communication modules that are compatible with the XP-8000-CE6.

| Item     | RS-232 | RS-422/RS-485 | Isolation | Connector            |
|----------|--------|---------------|-----------|----------------------|
| I-8112iW | 2      | -             | 2500 Vrms | DB-9 x 2             |
| I-8114W  | 4      | -             | -         | DB-37 x 1            |
| I-8114iW | 4      | -             | 2500 Vrms | DB-37 x 1            |
| I-8142iW | -      | 2             | 2500 Vrms | Terminator block x 1 |
| I-8144iW | -      | 4             | 2500 Vrms | Terminator block x 1 |

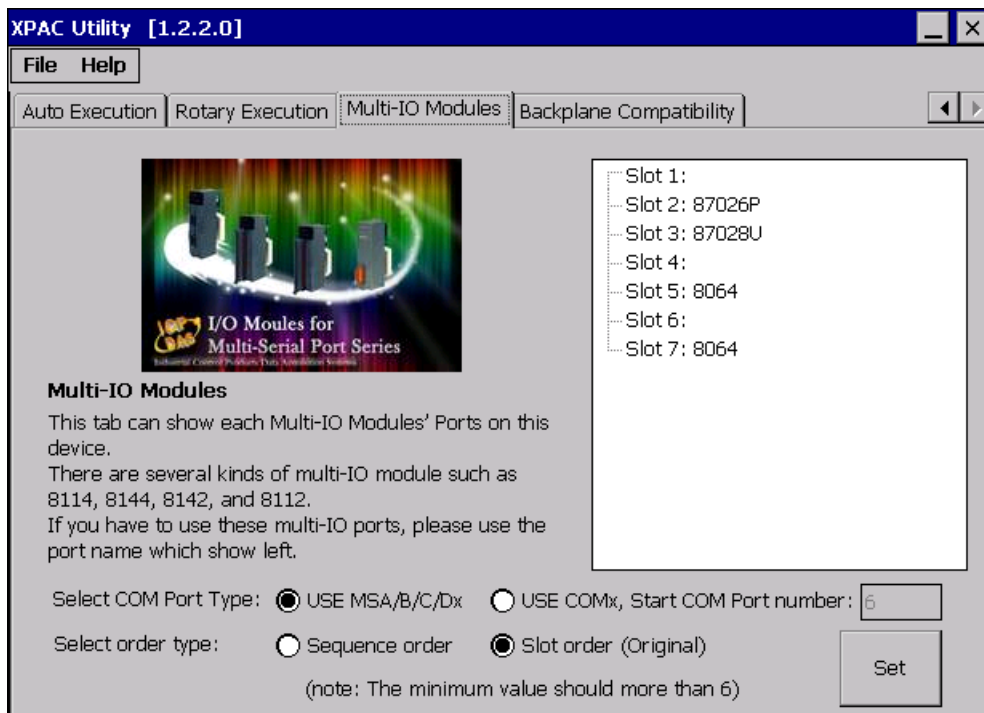

| The tab use to    | How to use  |
|-------------------|---|
| Set the port name | Select the name type and order type from the Selection COM Port Type and Select order type options, and then click the <b>Set</b> button. |

## 3.2. DCON Utility Pro

DCON Utility Pro enables users easily to configure and manage the I/O modules via Ethernet or serial ports (RS-232/RS-485).

For more information on how to use DCON Utility Pro to configure I/O modules, please refer to 2.6. Using DCON Utility Pro to Configure I/O Modules

For more detailed information on DCON Utility application, please refer to:

[http://www.icpdas.com/root/product/solutions/software/utilities/dcon\\_utility\\_pro.html](http://www.icpdas.com/root/product/solutions/software/utilities/dcon_utility_pro.html)

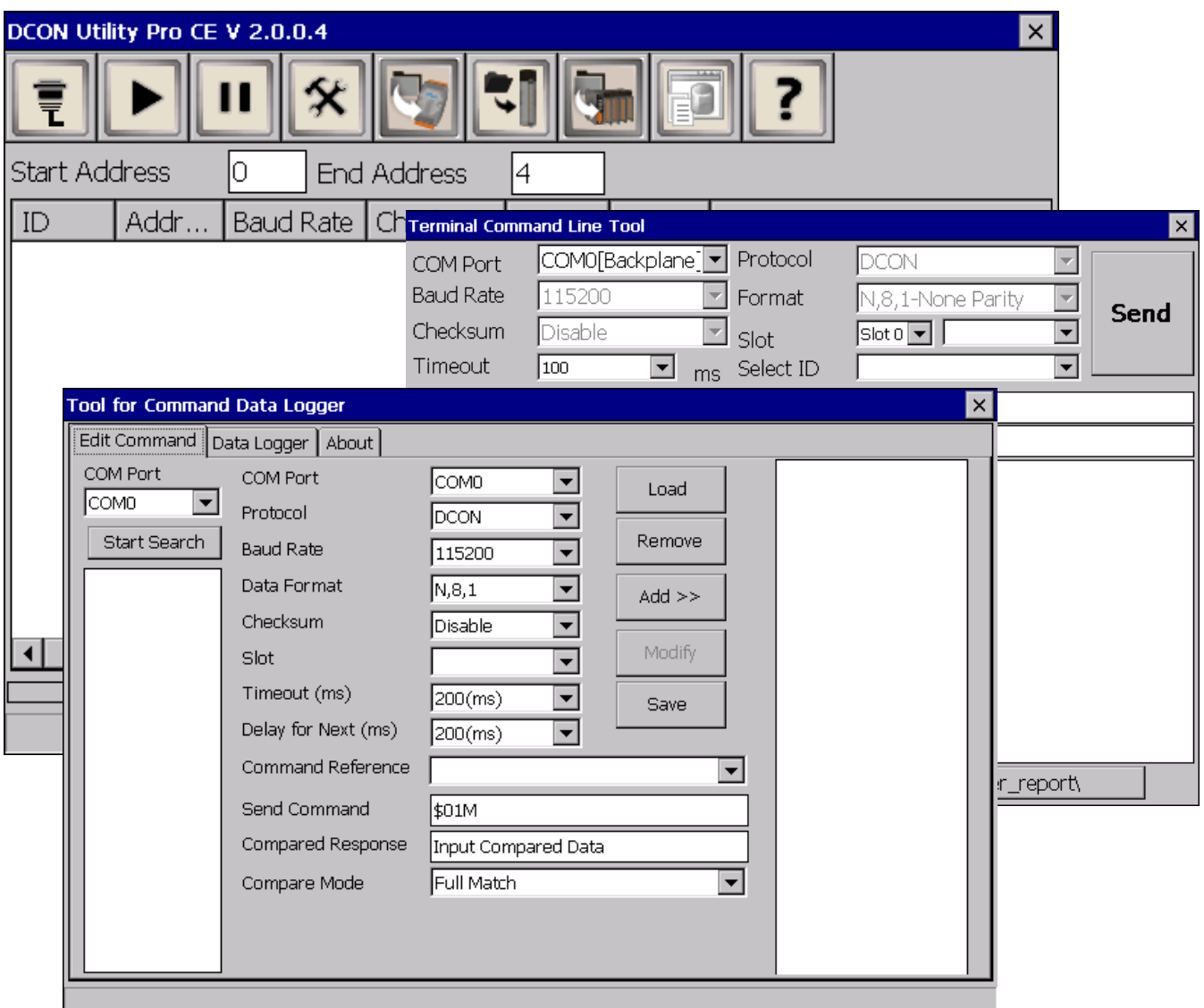

### 3.3. DCON\_CE

The DCON\_CE is a server program based that runs on XP-8000-CE6, and communicates with PC via DCON protocol.

The DCON Utility is a client utility that runs on PC, and communicates with XP-8000-CE6 via DCON protocol. The DCON Utility allows users to remotely connect to I-7K and I-87K series I/O modules for management through the COM port and Ethernet port.

This tool is composed of two parts, a client and a server. The server is a program named DCON\_CE\_XP running on XP-8000-CE6. The client is a PC-based program named DCON Utility running on the PC.

### 3.4. TaskMgr

The TaskMgr is a Windows CE application, which provides real time info on all processes and threads including System threads, similar in appearance to the Windows Task Manager.

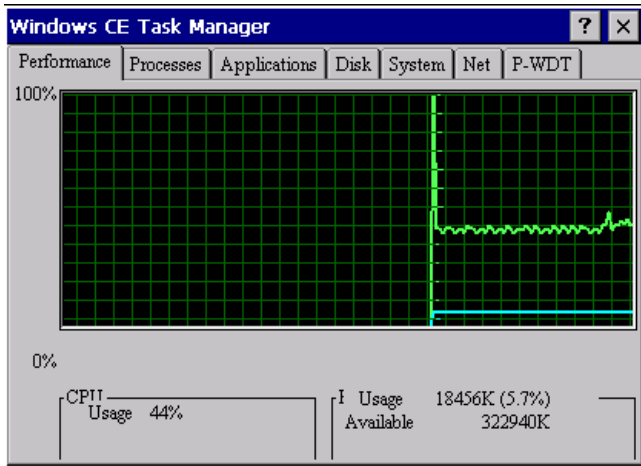

### 3.5. VCEP

ICP DAS VCEP is designed for managing your XP-8000-CE6 anywhere. No matter where you are, ICP DAS VCEP provides a convenient environment on the Desktop PC and lets you control your XP-8000-CE6 remotely.

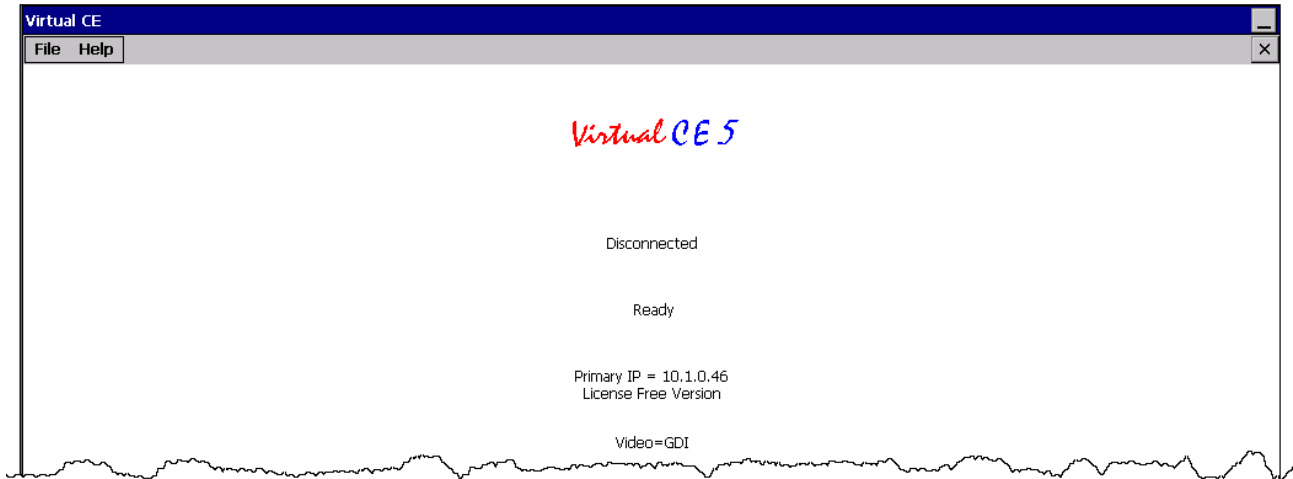

ICP DAS VCEP is composed of two main components: The **Server** which runs on XP-8000-CE6 and the **Client** which runs on a Desktop PC.

Once a connection is established between the client and server (initiated by the client), the client will periodically send requests for screen updates and send mouse/key click information to the server to simulate.

Each video frame is inter-compressed against the previous frame and then intra-compressed with a modified LZW scheme to minimize the amount of data transmitted from server to client.

For more detailed information on VCEP application, please refer to <http://www.icpdas.com/root/product/solutions/software/utilities/vecp/vecp.html>

### 3.6. Remote\_Display

The **Remote Display** allows XP-8000-CE6 to be controlled and monitored from a remote location.

This tool is composed of two parts, a client and a server. The server is a program named `cerdisp.exe` running on XP-8000-CE6. The client is a PC-based program named `cerhost.exe` running on the PC.

Once a connection is established between the client and server (initiated by the client), the client will periodically send requests for screen updates and send mouse/key click information to the server to simulate.

### 3.7. SendToCOM

The **SendToCOM** uses the serial port to communicate with expansion module. To use the SendToCOM, you can send data to expansion module through the serial port, and receive data from other device through the serial port.

For more information about these commands for communicating with expansion module, please refer to:

[http://www.icpdas.com/root/product/solutions/remote\\_io/rs-485/i-8k\\_i-87k/i-8k\\_i-87k\\_selection.html#b](http://www.icpdas.com/root/product/solutions/remote_io/rs-485/i-8k_i-87k/i-8k_i-87k_selection.html#b)

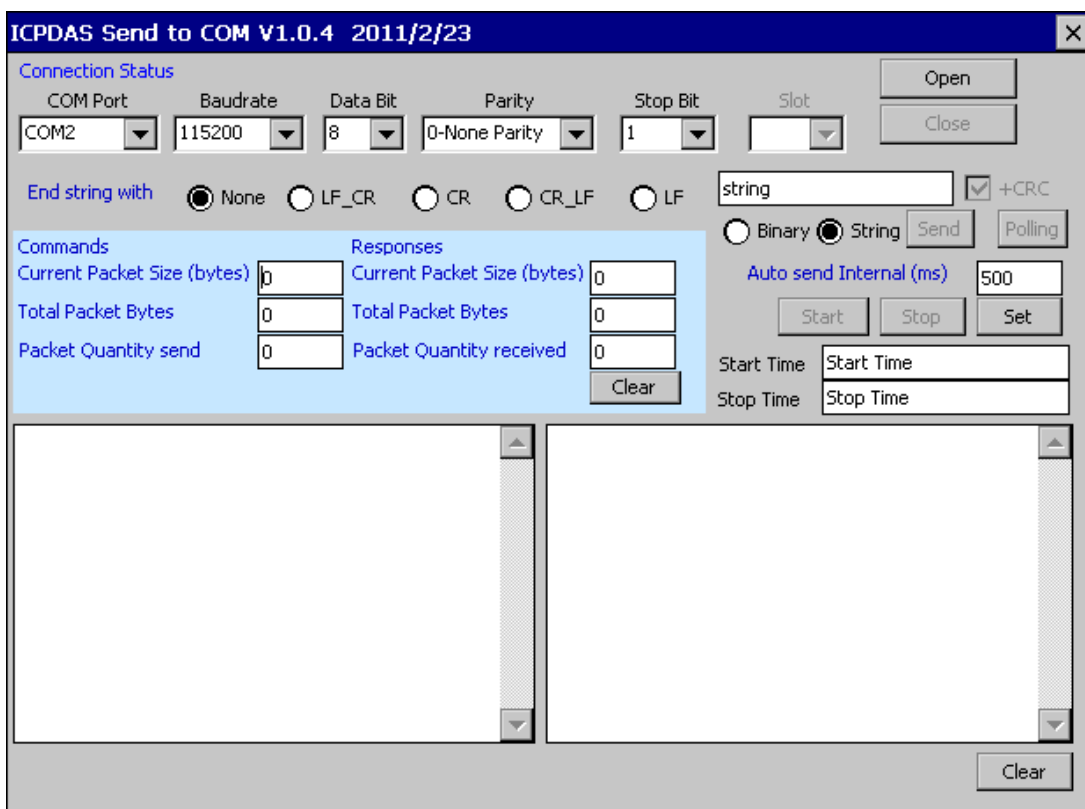

### 3.8. RegEdit

The **RegEdit** provides a hierarchical representation of the registry on a target computer, similar in appearance to the Windows Registry Editor. The standard registry roots are represented; you can add keys beneath a root to point to existing registry keys, or you can add your own keys. Values can be changed for existing keys, or added for new keys, and default keys can be specified.

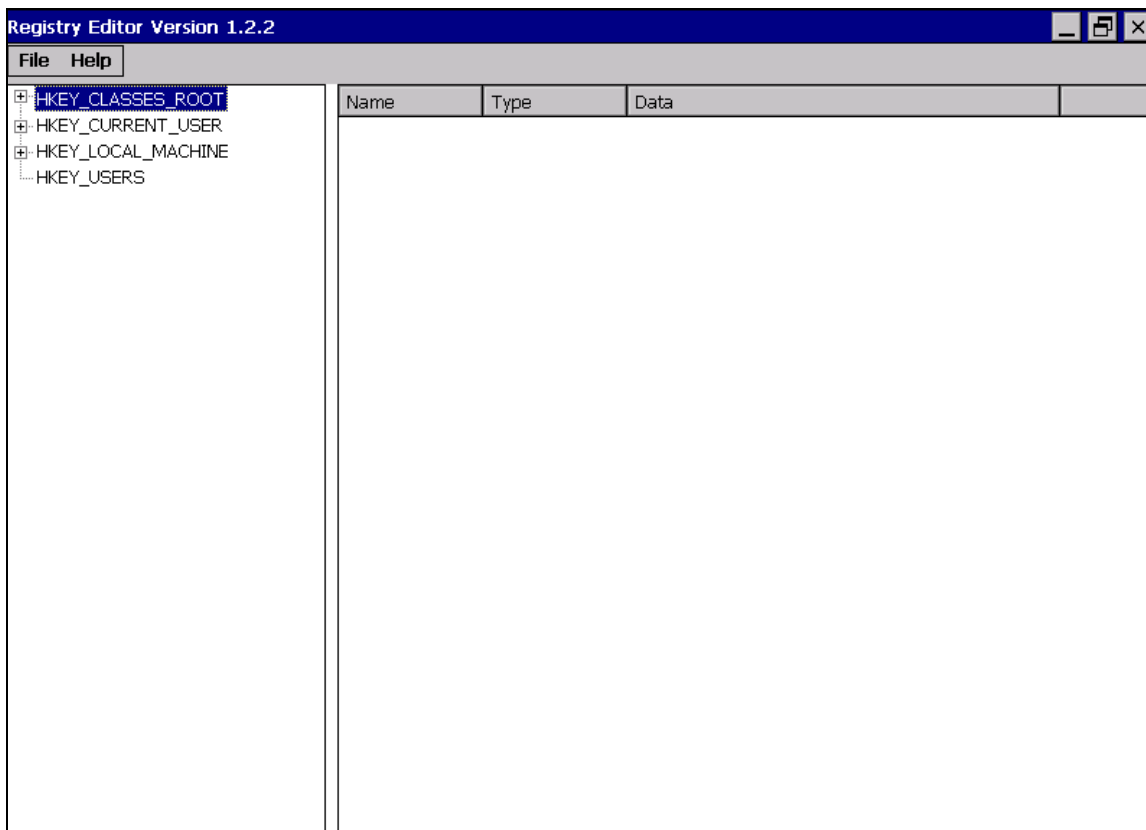



### 3.9. ISQLW35

The **ISQLW35** is a Windows Embedded Compact 6 functionality that implements SQL Server Compact 3.5 Query.

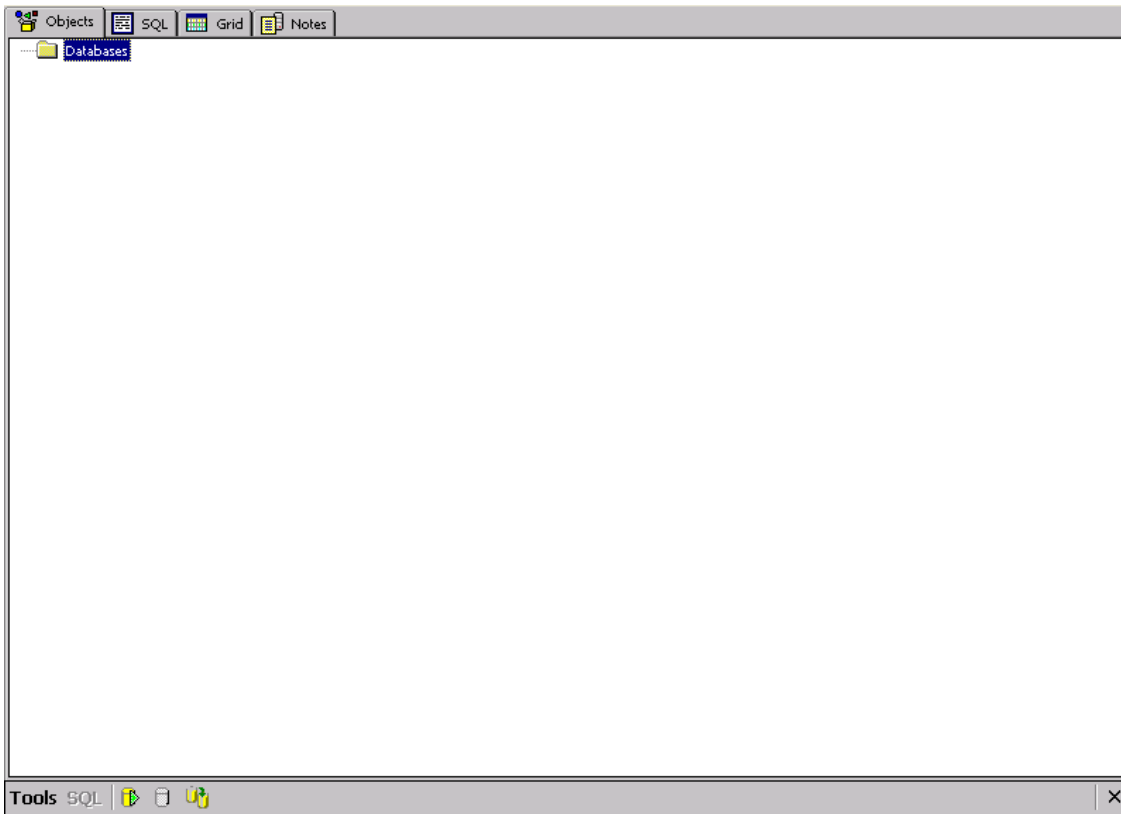

### 3.10. INotepad

The **INotepad** is a common text-only editor. The resulting files have no format tags or styles.

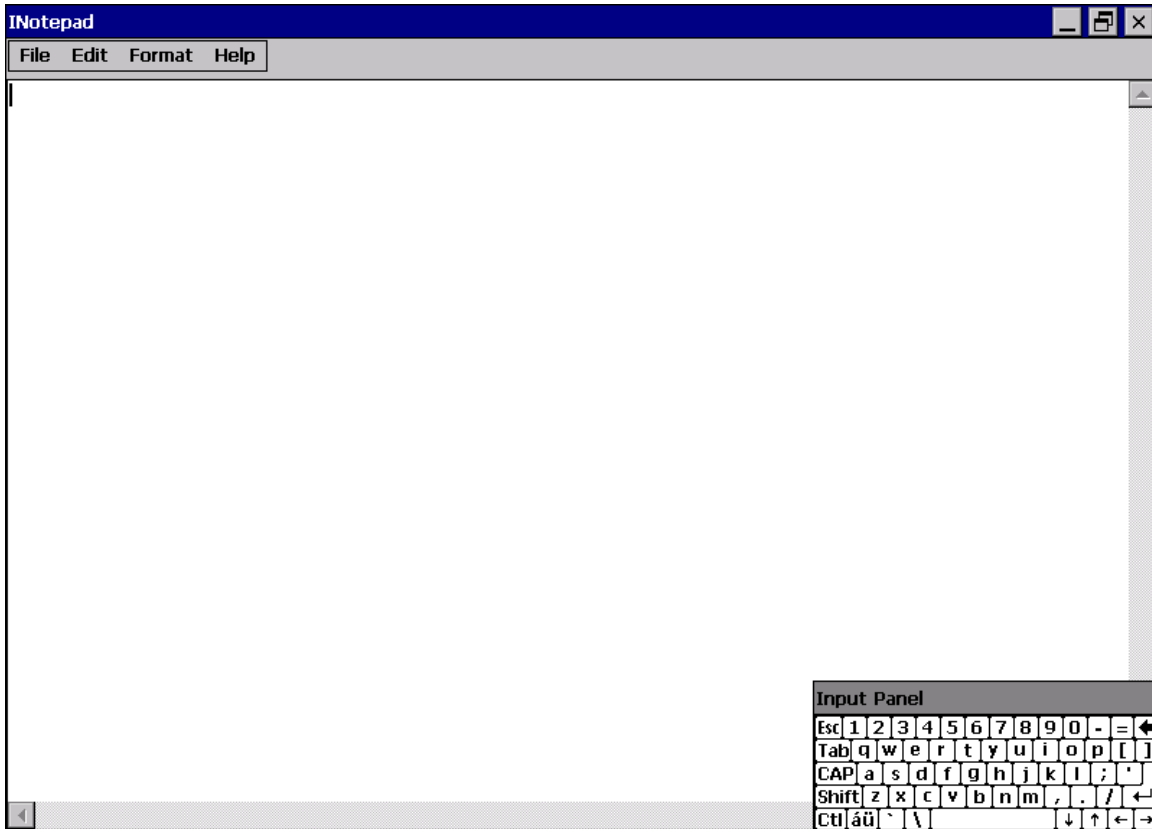

## 4. Your First XP-8000-CE6 Program

This chapter provides a guided tour that describes the steps needed to set-up a development environment, download, install, configure for user programming with XP-8000-CE6.

### 4.1. Setting up the Development Environment

Before writing your first program, ensure that you have the necessary development tool and the corresponding SDKs are installed on your system.

### 4.1.1. Preparing the Development Tools

XP-8000-CE6 has .NET Compact Framework 3.5 installed. Visual Studio takes full advantage of the .NET Compact Framework, which uses public Internet standards to enable integration with new and existing applications running on any platform.

Supported languages include

- Visual Basic.NET
- Visual C#
- Visual C++

---

#### Tips & Warnings



1. There is no support for development of both managed and unmanaged code on XP-8000-CE6 platform in VS2010/VS2012.
  2. WinCE-based platform development is only supported in Visual studio Professional edition or better, no Express or Standard edition.
- 

The table below provides a summary of the supported development tools and languages required for developing XP-8000-CE6 applications.

| Development Tool              |                                 | Language | Visual Basic .Net | Visual C# | Visual C++ |
|-------------------------------|---------------------------------|----------|-------------------|-----------|------------|
| Visual Studio 2005 or earlier | Any version except Professional |          | --                | --        | --         |
|                               | <b>Professional</b>             |          | ✓                 | ✓         | ✓          |
| Visual Studio 2008            | Any version except Professional |          | --                | --        | --         |
|                               | <b>Professional</b>             |          | ✓                 | ✓         | ✓          |
| Visual Studio 2010 or later   | Any version except Professional |          | --                | --        | --         |
|                               | Professional                    |          | --                | --        | --         |

✓: Supported, --: Unsupported

## 4.1.2. Installing the XP-8000-CE6 SDK

The XP-8000-CE6 SDK offers several APIs for customizing the standard features and integrating with other applications, devices and services.

### Step 1: Get the latest version of the XP-8000-CE6 SDK

The XP-8000-CE6 SDK can be found from the CD that was provided with the package or by downloading the latest version from ICP DAS web site.

CD:\XP-8X3X-CE6\SDK\PlatformSDK\

<http://ftp.icpdas.com/pub/cd/xp-8x3x-ce6/sdk/platformsdk/>

**File name:** PACSDK\_CE\_n.n.n\_Vxxxx.msi

- n.n.n : platform sdk version number
- xxxx: 2005 indicates VS2005, 2008 indicates VS2008

### Step 2: Execute the PACSDK\_CE\_n.n.n\_Vxxxx.msi

Follow the prompts until the installation process is complete.

## 4.2. First XP-8000-CE6 Program in VB.NET

The best way to learn programming with XP-8000-CE6 is to actually create a XP-8000-CE6 program.

The example below demonstrates how to create a demo program running on XP-8000-CE6 with VB.NET.

To create a demo program with VB.NET that includes the following main steps:

1. Create a new project
2. Specify the path of the PAC reference
3. Add the control to the form
4. Add the event handling for the control
5. Upload the application to XP-8000-CE6
6. Execute the application on XP-8000-CE6

All main steps will be described in the following subsection.

In this tutorial, we will assume that you have installed XP-8000-CE6 SDK on PC and used the Visual Studio 2008 for application development.

### 4.2.1. Create a new project

The Visual VB.net project template is a composite control that you use in this example creates a new project with this user control.

#### Step 1: Start Visual Studio 2008



#### Step 2: On the File menu, point to New, and then click Project

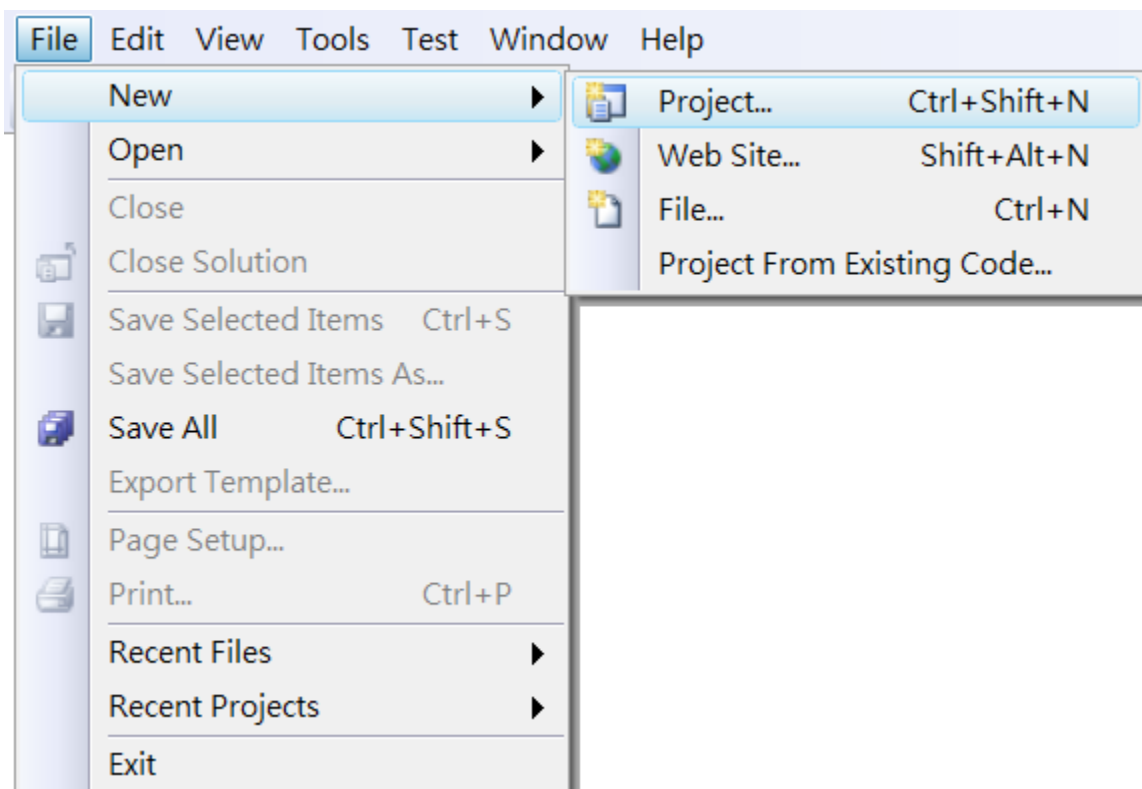

**Step 3: In the Project types pane, expand Visual Basic node and select Smart Device**

**Step 4: In the list of Templates, select Smart Device Project**

**Step 5: Specify a name and a location for the application and then click OK**

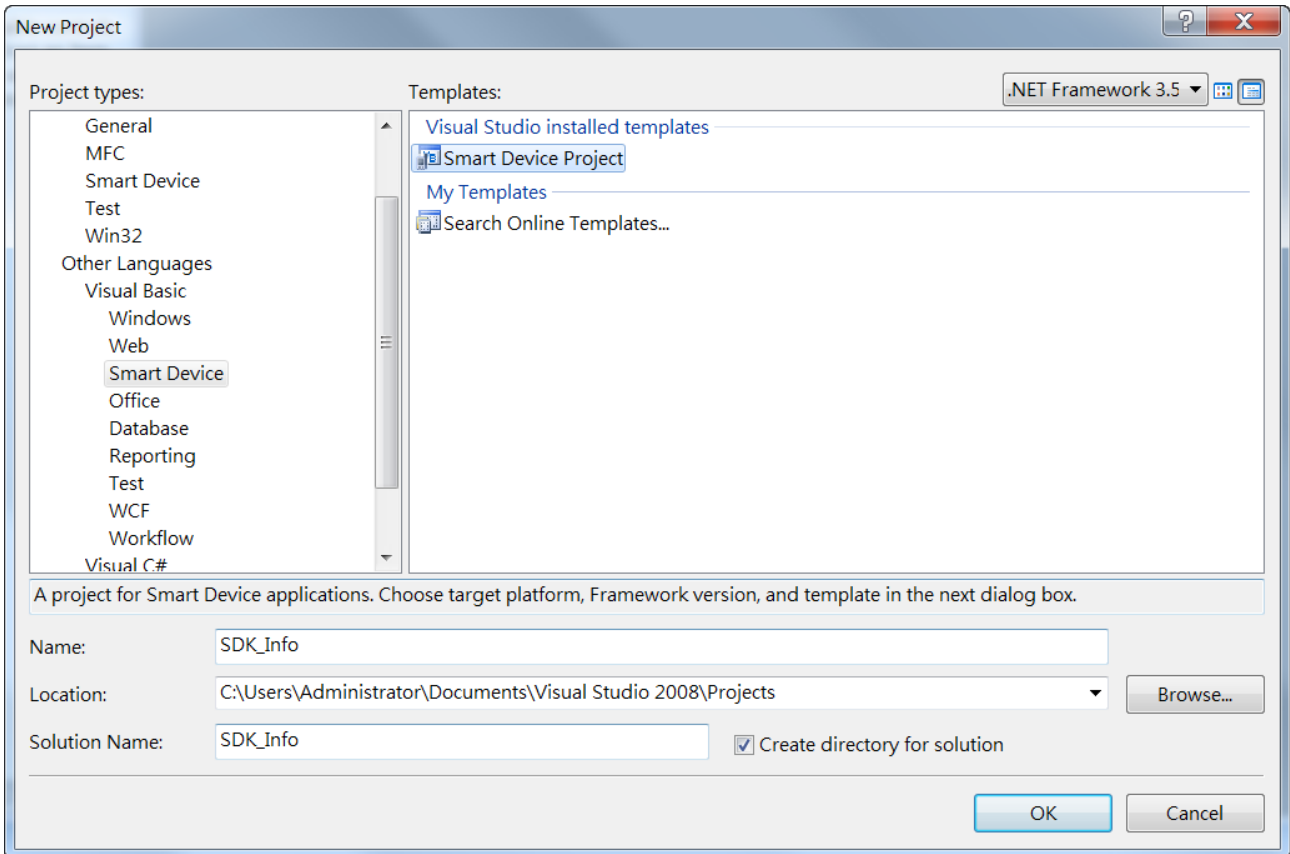



**Step 6: In the Target platform, select Windows CE**

**Step 7: In the .NET Compact Framework version, select .NET Compact Framework Version 3.5.**

**Step 8: In the list of templates, select Device Application. Click OK**

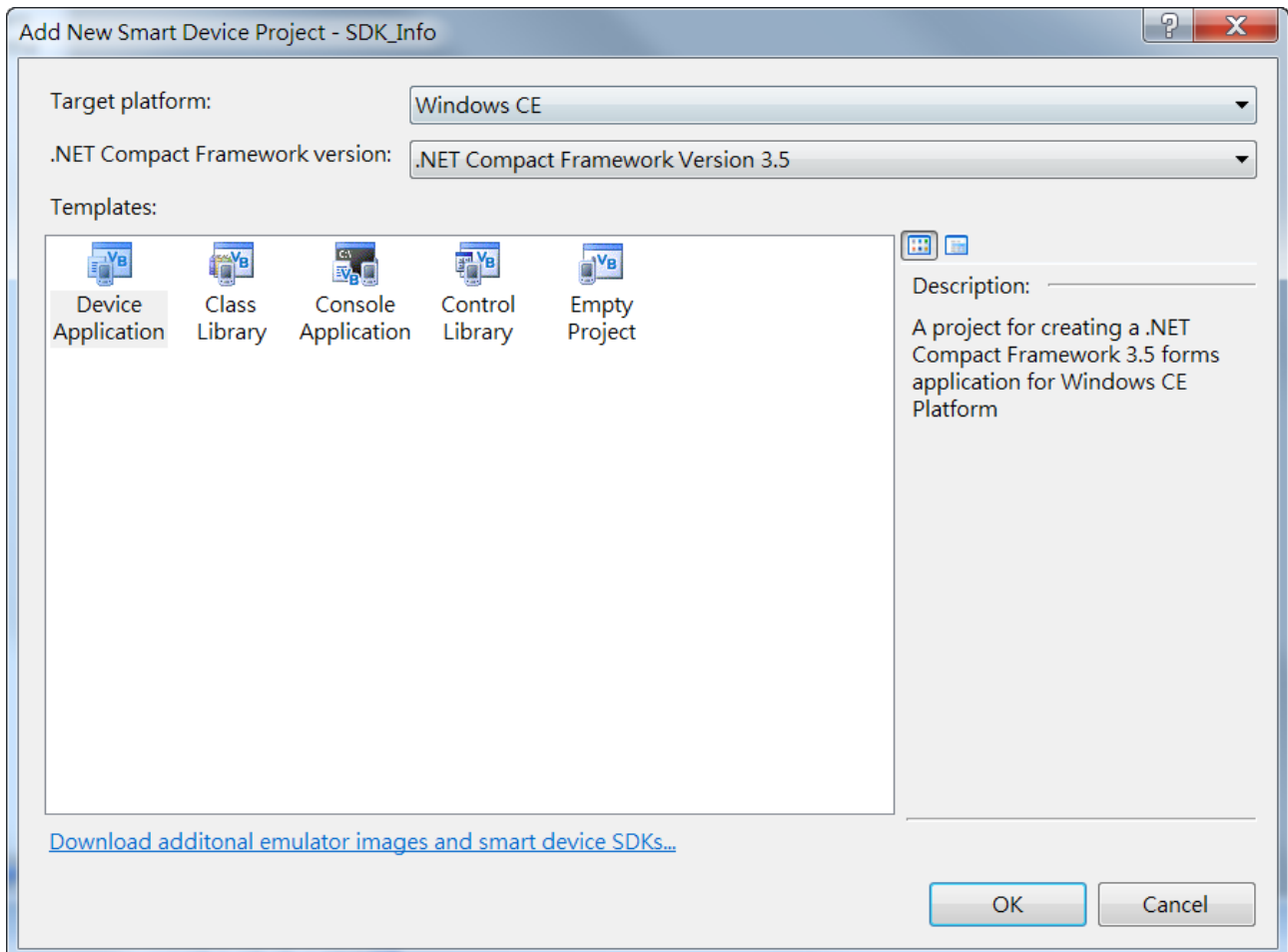

## 4.2.2. Specify the path of the PAC reference

The PAC SDK provides a complete solution to integrate with XP-8000-CE6 and it's compatible with Visual C#, Visual Basic.NET and C++. In order to use a component in your application, you must first add a reference to it.

### Step1: Get the PACNET.dll



The PACNET.dll can be found from the CD that was provided with the package or by downloading the latest version from ICP DAS web site.

CD:\XP-8X3X-CE6\SDK\XPacNET\PACNET\

<http://ftp.icpdas.com/pub/cd/xp-8x3x-ce6/sdk/xpacnet/pacnet/>

### Step 2: On the Project menu, and then click Add Reference...

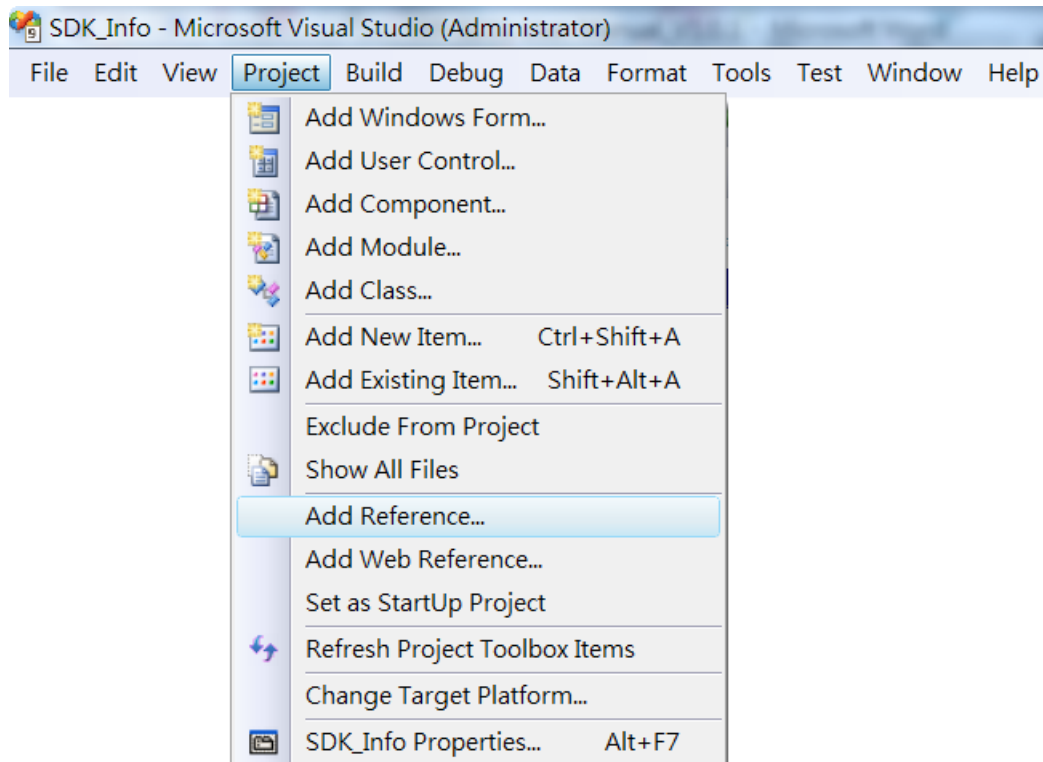

**Step 3: On the Browse tab and browse to where the PACNET.dll are installed, and then click OK**

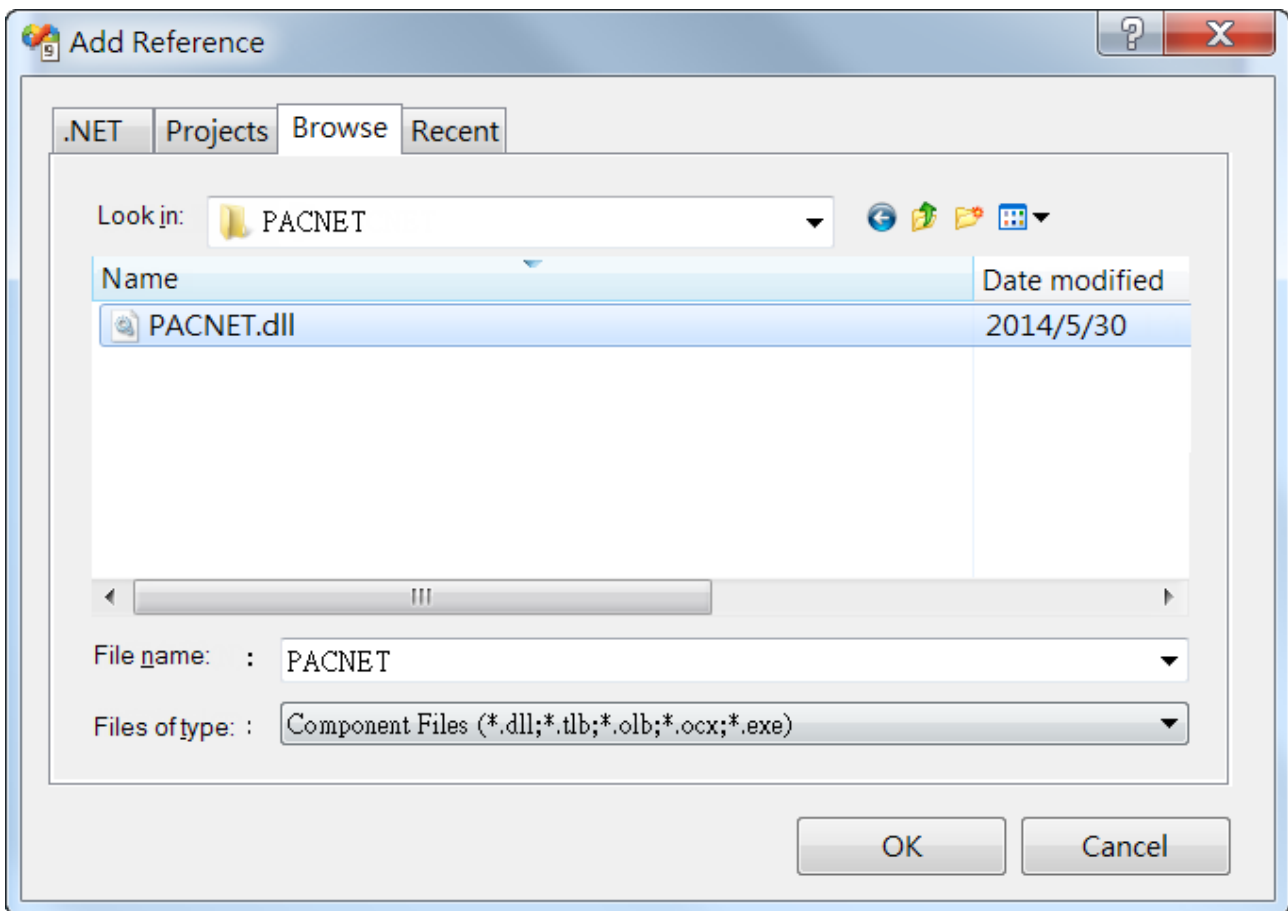

### 4.2.3. Add the control to the form

You can drag various controls from the Toolbox onto the form. These controls are not really "live"; they are just images that are convenient to move around on the form into a precise location.

After you add a control to your form, you can use the Properties window to set its properties, such as background color and default text. The values that you specify in the Properties window are the initial values that will be assigned to that property when the control is created at run time.

#### Step 1: On the Toolbox panel, drag a Button control onto the form

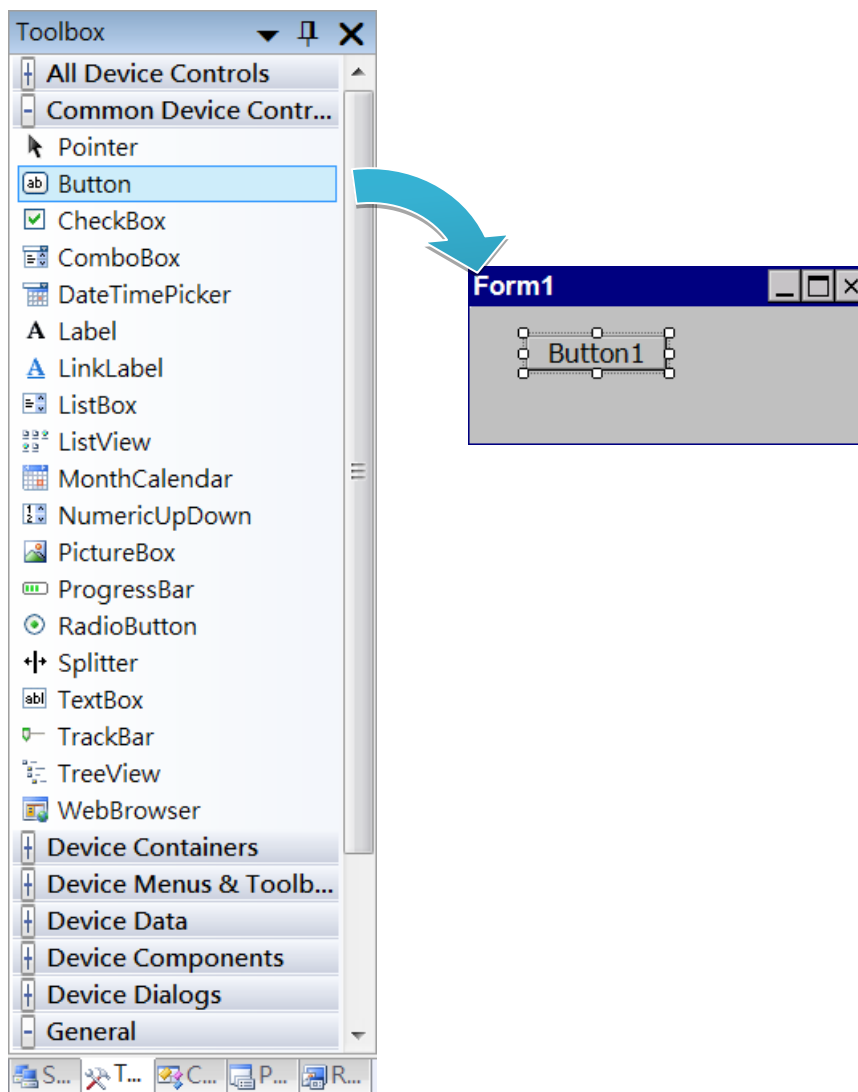

**Step 2: On the Properties panel, type Check the SDK version in the Text field**

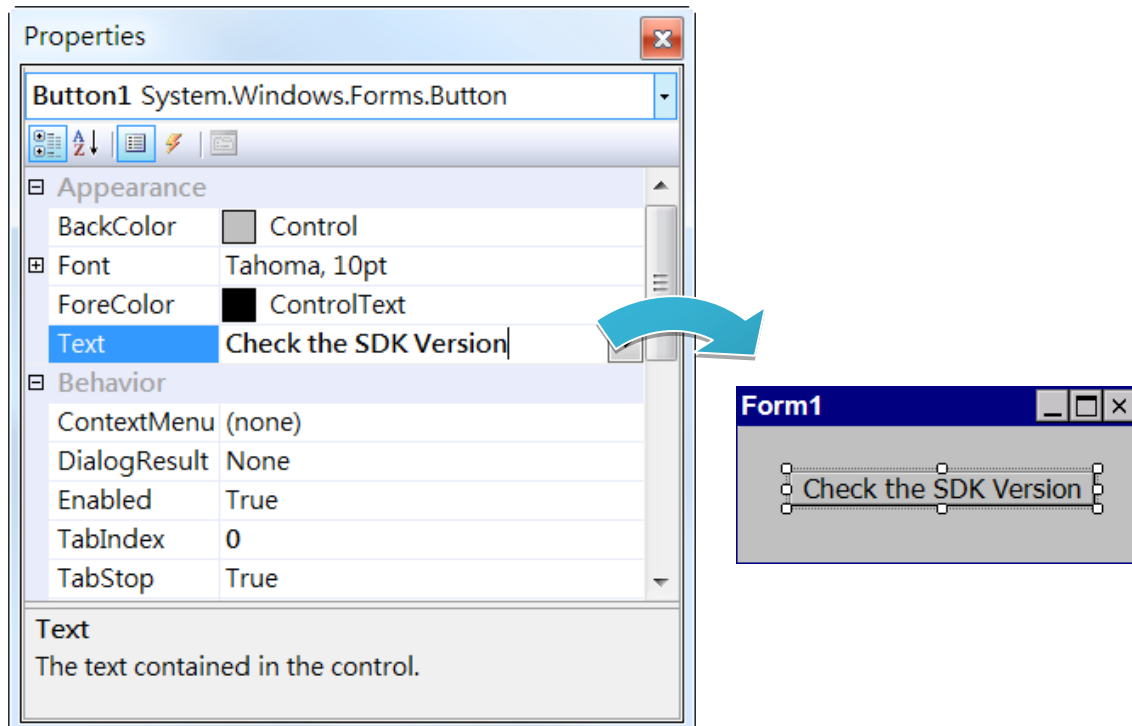

#### 4.2.4. Add the event handling for the control

You have finished the design stage of your application and are at the point when you can start adding some code to provide the program's functionality.

##### Step 1: Double-click the button on the form

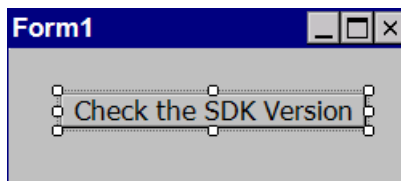

##### Step 2: Inserting the following code

```
Dim data(30) As Byte
PACNET.Sys.GetSDKVersion(data)
MessageBox.Show(PACNET.MISC.WideString(data))
```

```
Public Class Form1
    Private Sub Button1_Click(ByVal sender As System.Object, ByVal e As EventArgs)
        Dim data(30) As Byte
        PACNET.Sys.GetSDKVersion(data)
        MessageBox.Show(PACNET.MISC.WideString(data))
    End Sub
End Class
```

#### Tips & Warnings



The "PACNET" of "using PACNET" is case-sensitive.

#### 4.2.5. Upload the application to XP-8000-CE6

XP-8000-CE6 supports FTP server service. You can upload files to XP-8000-CE6 or download files from a public FTP server.

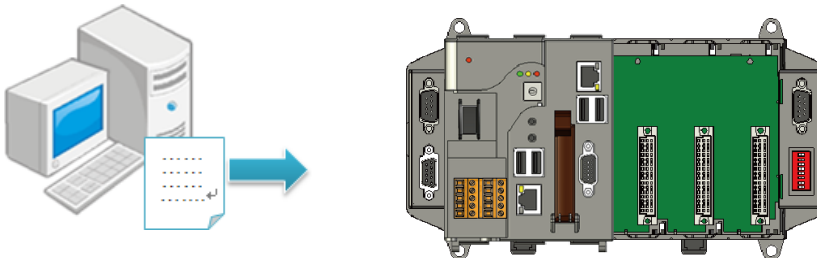

**Step 1: On the Build menu, and then click Build [Project Name]**

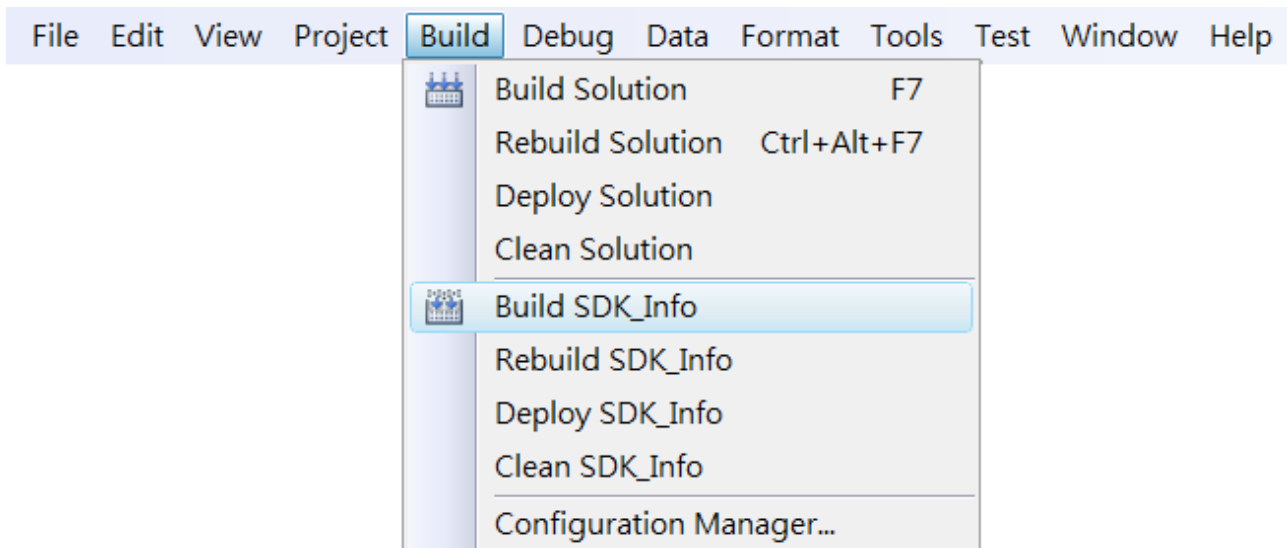

**Step 2: Open the browser and type the IP address of XP-8000-CE6**

**Step 3: Upload the application and the corresponding PACNET.dll files to XP-8000-CE6**

### Tips & Warnings

---



For applications programming in C# and VB.net with .net compact framework, when executing these application on XP-8000-CE6, the corresponding PACNET.dll must be in the same directory as the .exe file.

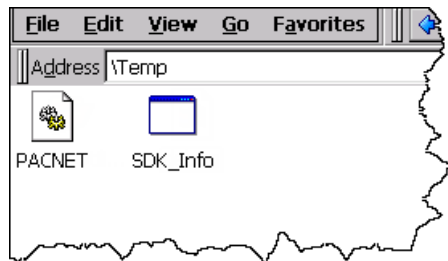



#### 4.2.6. Execute the application on XP-8000-CE6

After uploading the application to XP-8000-CE6, you can just double-click it on XP-8000-CE6 to execute it.

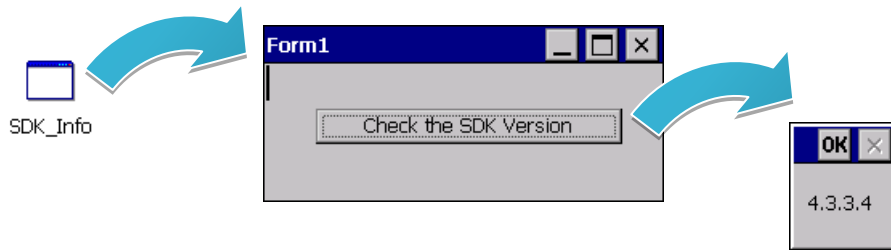

### 4.3. First XP-8000-CE6 Program in Visual C#

The best way to learn programming with XP-8000-CE6 is to actually create a XP-8000-CE6 program.

The example below demonstrates how to create a demo program running on XP-8000-CE6 with Visual C#.

To create a demo program with Visual C# that includes the following main steps:

1. Create a new project
2. Specify the path of the PAC reference
3. Add the control to the form
4. Add the event handling for the control
5. Upload the application to XP-8000-CE6
6. Execute the application on XP-8000-CE6

All main steps will be described in the following subsection.

In this tutorial, we will assume that you have installed XP-8000-CE6 SDK on PC and used the Visual Studio 2008 for application development.

### 4.3.1. Create a new project

The Visual C# project template is a composite control that you use in this example creates a new project with this user control.

#### Step 1: Start Visual Studio 2008



#### Step 2: On the File menu, point to New, and then click Project

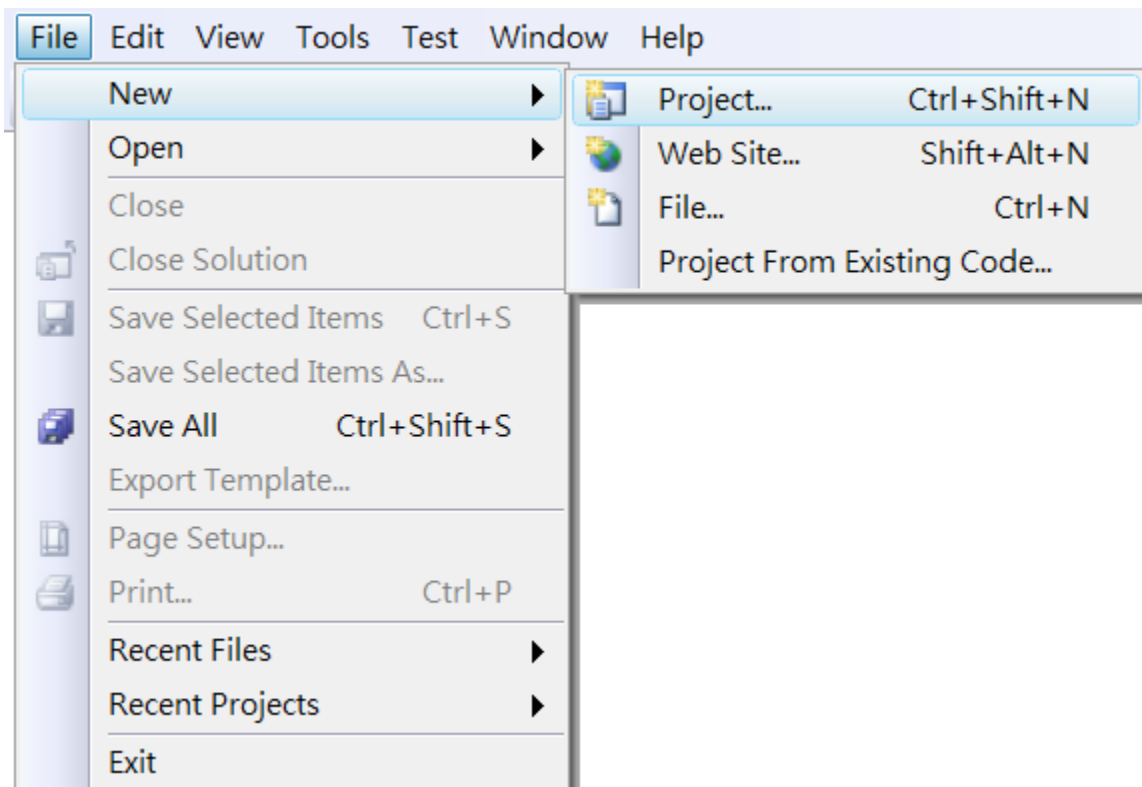

**Step 3: In the Project types pane, expand Visual C# node and select Smart Device**

**Step 4: In the list of Templates, select Smart Device Project**

**Step 5: Specify a name and a location for the application and then click OK**

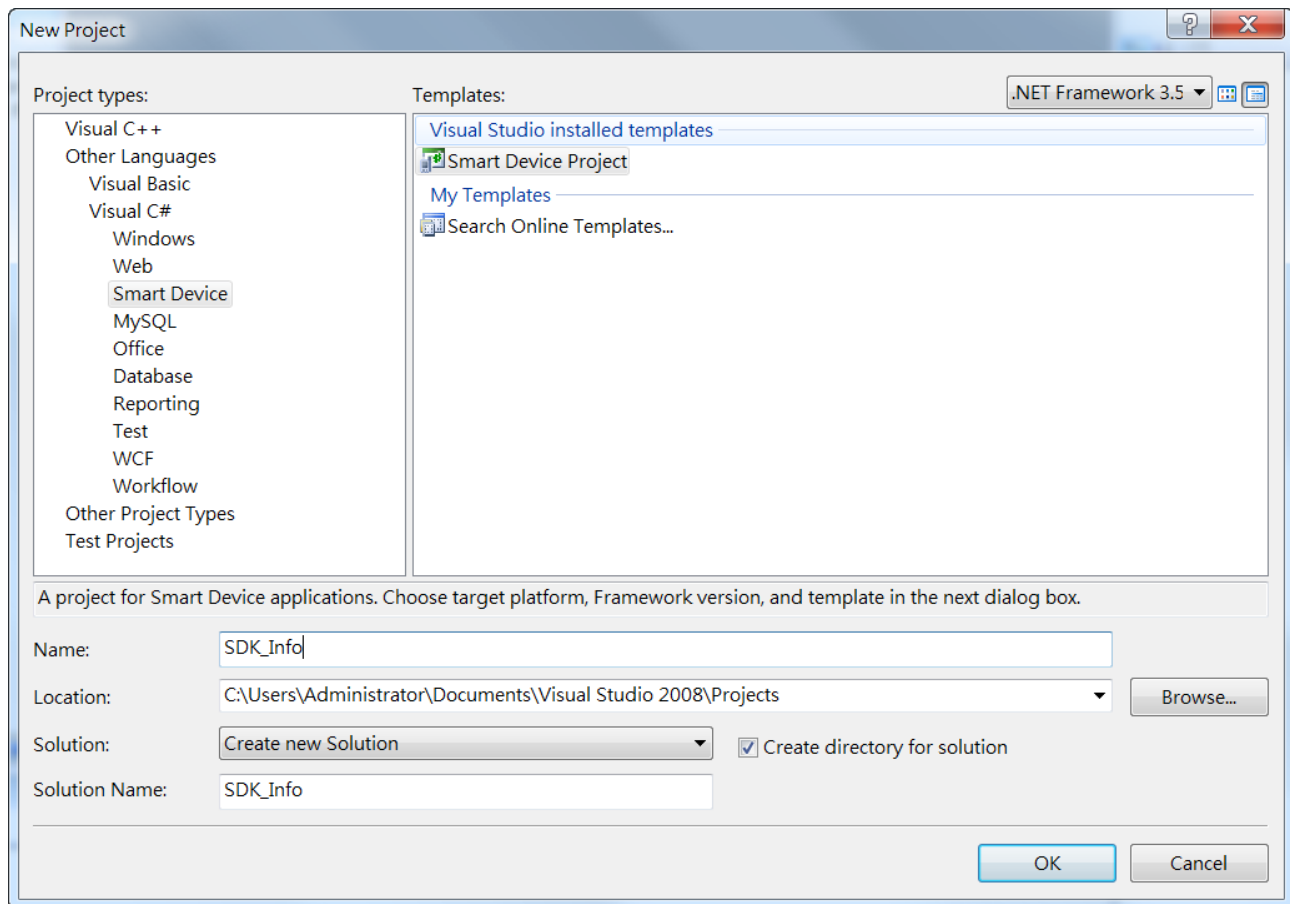

**Step 6: In the Target platform, select Windows CE**

**Step 7: In the .NET Compact Framework version, select .NET Compact Framework Version 3.5.**

**Step 8: In the list of templates, select Device Application. Click OK**

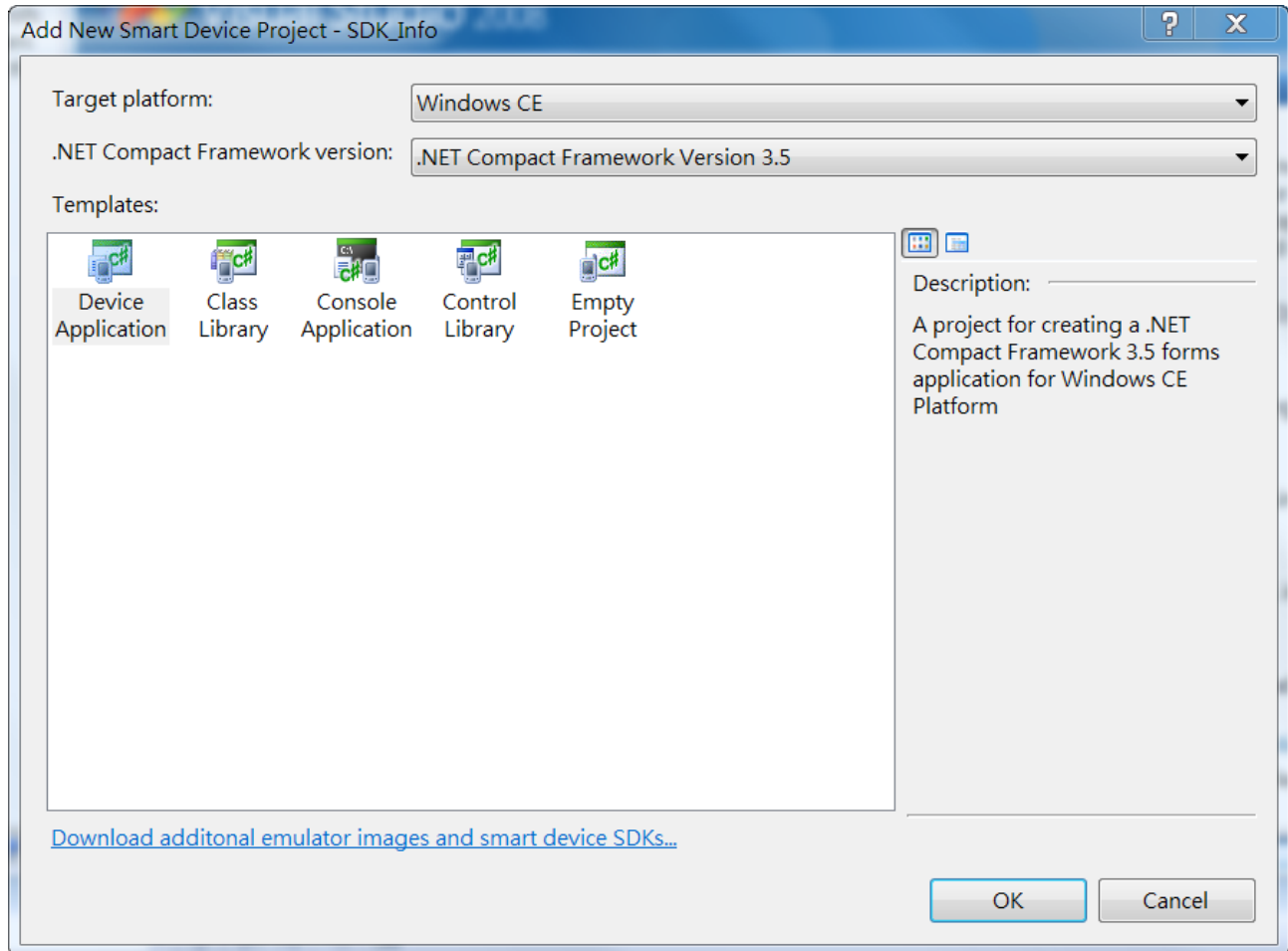

### 4.3.2. Specify the path of the PAC reference

The PAC SDK provides a complete solution to integrate with XP-8000-CE6 and it's compatible with Visual C#, Visual Basic.NET and C++. In order to use a component in your application, you must first add a reference to it.

#### Step1: Get the PACNET.dll



The PACNET.dll can be found from the CD that was provided with the package or by downloading the latest version from ICP DAS web site.

CD:\XP-8X3X-CE6\SDK\XPacNET\PACNET\

<http://ftp.icpdas.com/pub/cd/xp-8x3x-ce6/sdk/xpacnet/pacnet/>

#### Step 2: On the Project menu, and then click Add Reference...

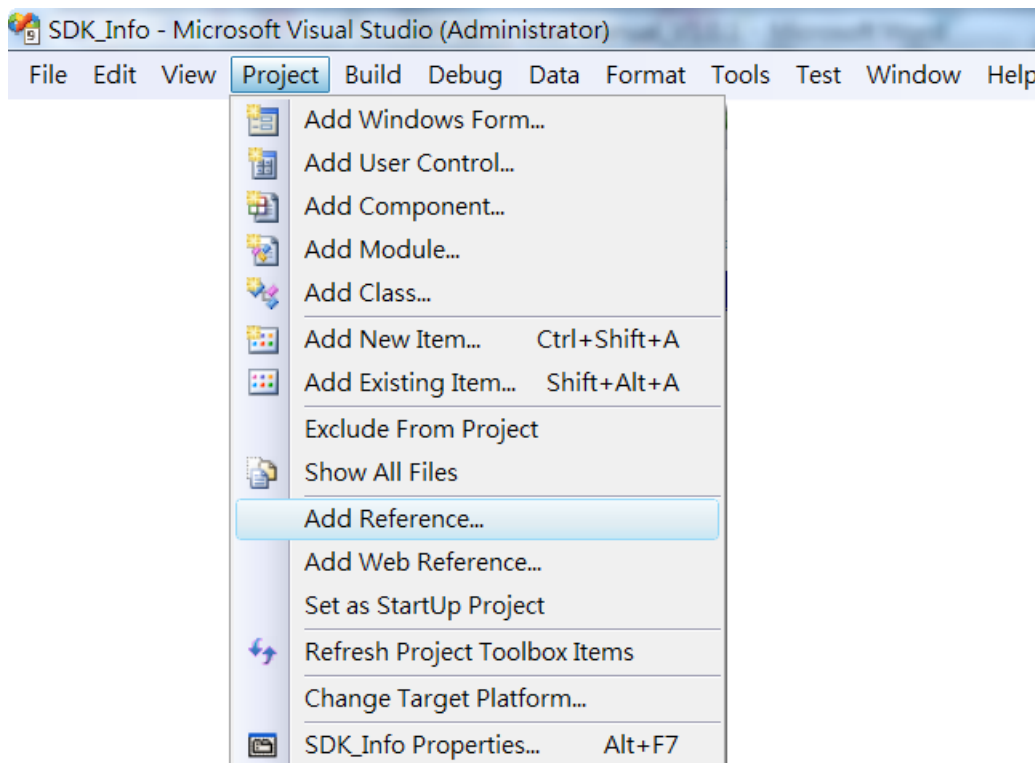

**Step 3: On the Browse tab and browse to where the PACNET.dll are installed, and then click OK**

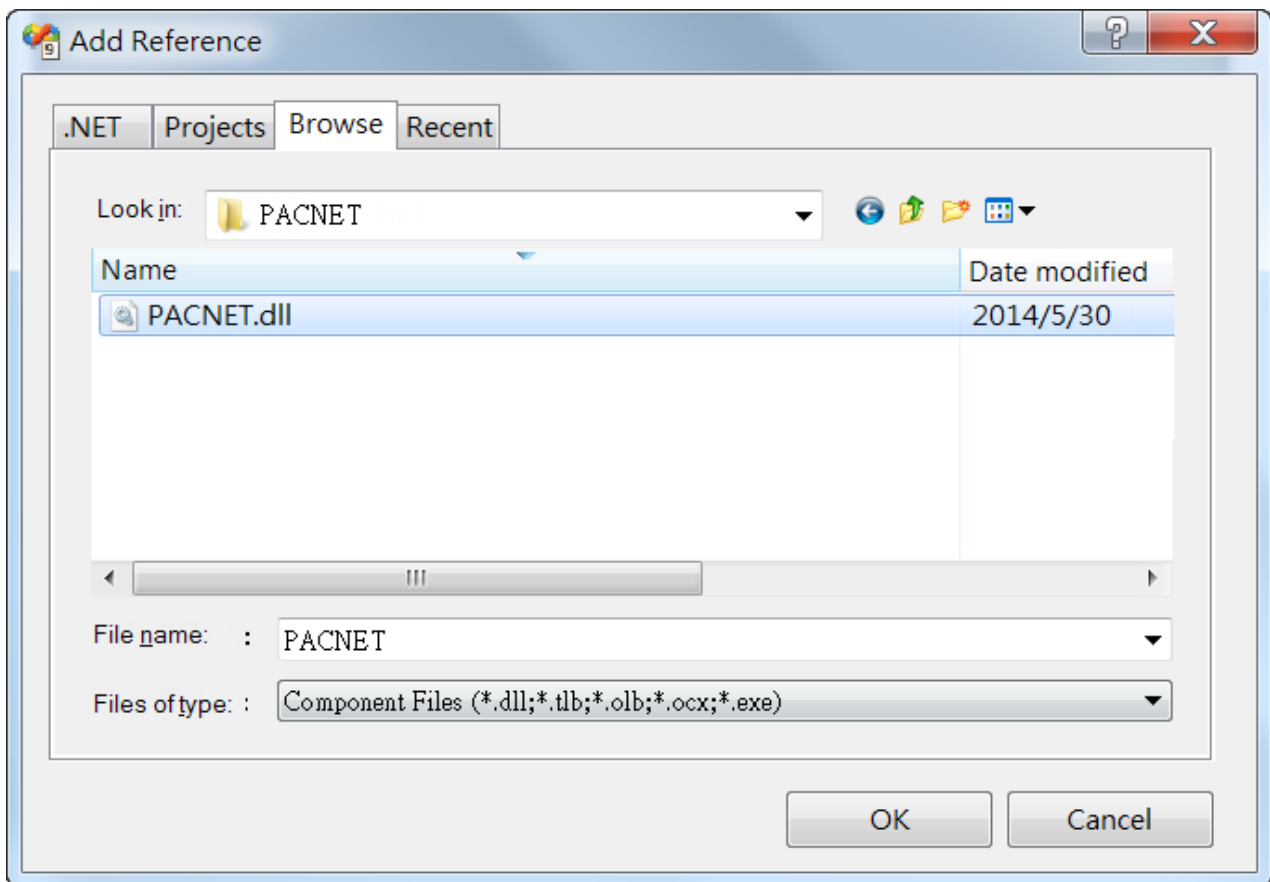

### 4.3.3. Add the control to the form

You can drag various controls from the Toolbox onto the form. These controls are not really "live"; they are just images that are convenient to move around on the form into a precise location.

After you add a control to your form, you can use the Properties window to set its properties, such as background color and default text. The values that you specify in the Properties window are the initial values that will be assigned to that property when the control is created at run time.

#### Step 1: On the Toolbox panel, drag a Button control onto the form

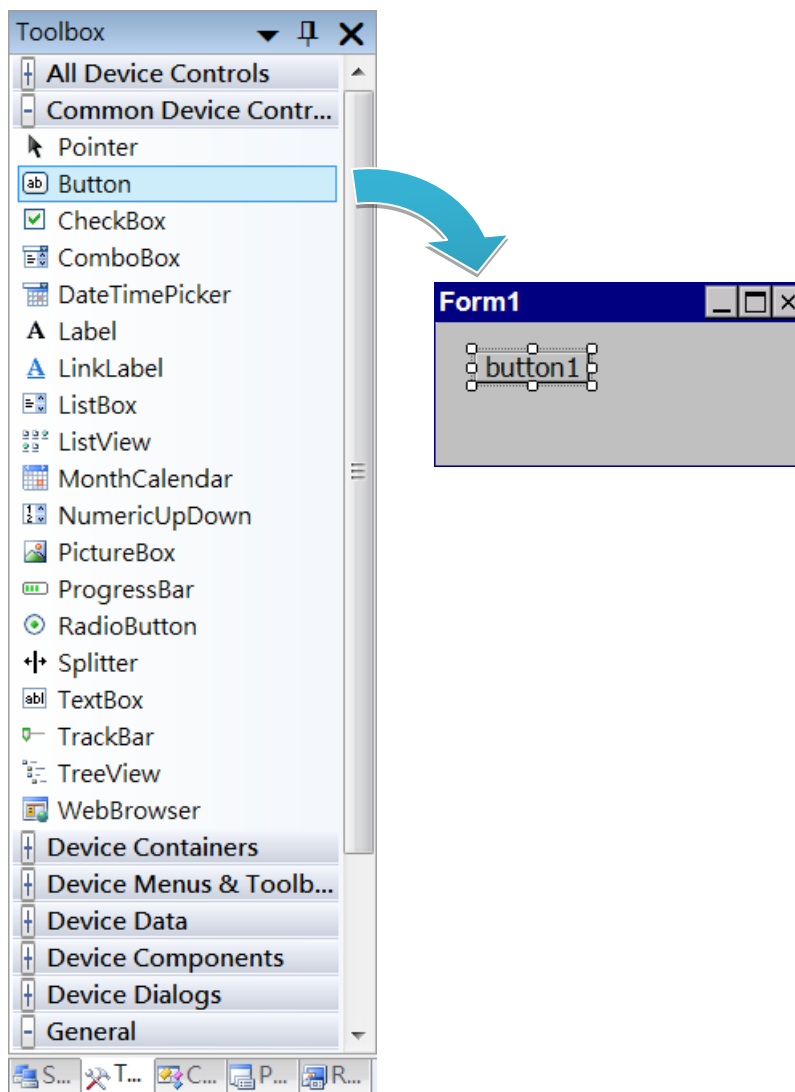



**Step 2: On the Properties panel, type Check the SDK version in the Text field**

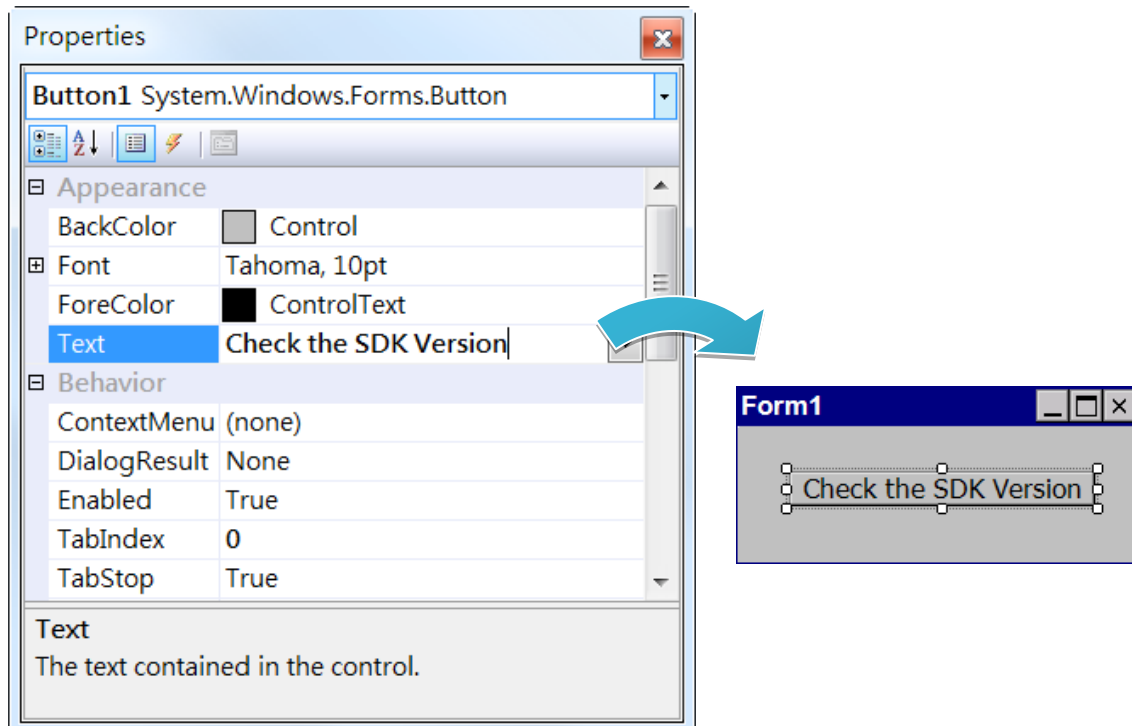

#### 4.3.4. Add the event handling for the control

You have finished the design stage of your application and are at the point when you can start adding some code to provide the program's functionality.

##### Step 1: Double-click the button on the form

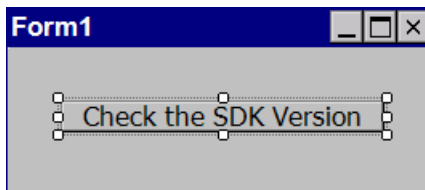

##### Step 2: Inserting the following code

```
byte[] data = new byte[30];  
PACNET.Sys.GetSDKVersion(data);  
MessageBox.Show(PACNET.MISC.WideString(data));
```

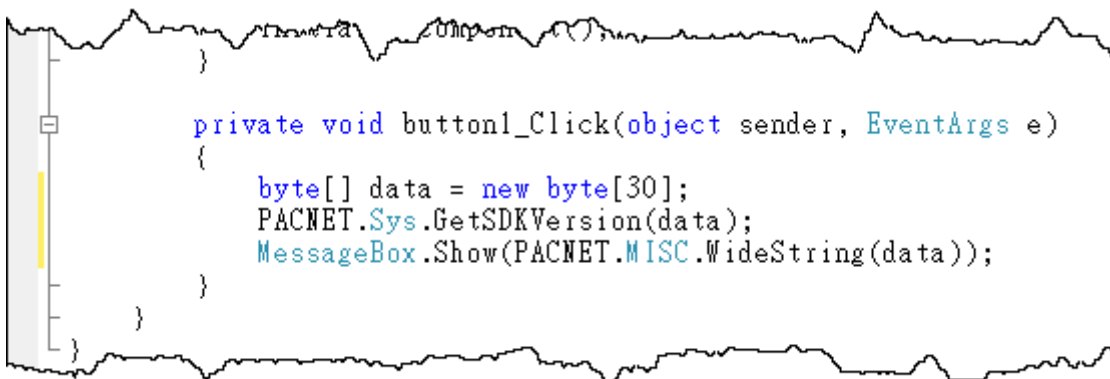

#### Tips & Warnings



The "PACNET" of "using PACNET" is case-sensitive.

### 4.3.5. Upload the application to XP-8000-CE6

XP-8000-CE6 supports FTP server service. You can upload files to XP-8000-CE6 or download files from a public FTP server.

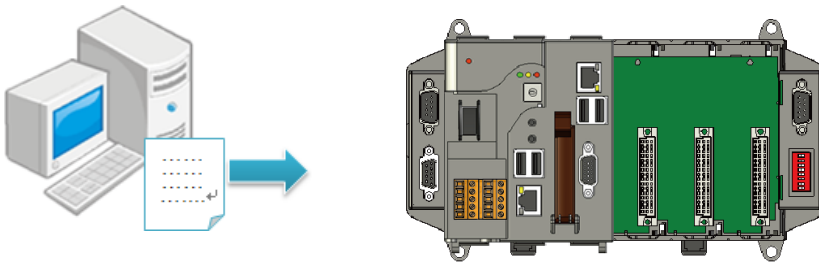

**Step 1: On the Build menu, and then click Build [Project Name]**

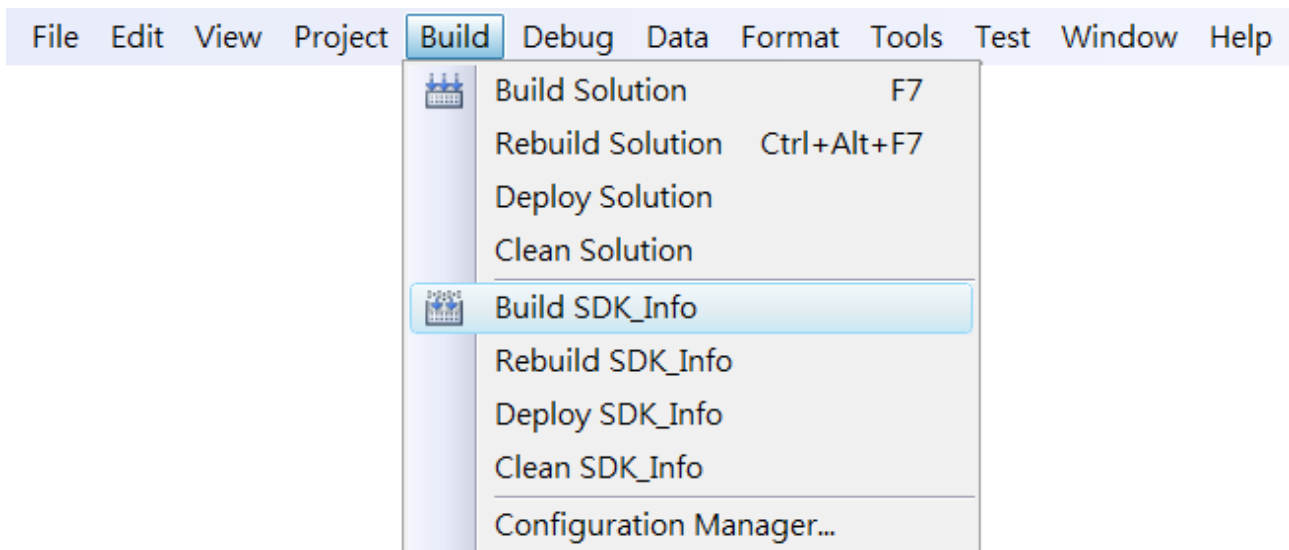

**Step 2: Open the browser and type the IP address of XP-8000-CE6**

**Step 3: Upload the application and the corresponding PACNET.dll files to XP-8000-CE6**

### Tips & Warnings

---



For applications programming in C# and VB.net with .net compact framework, when executing these application on XP-8000-CE6, the corresponding PACNET.dll must be in the same directory as the .exe file.

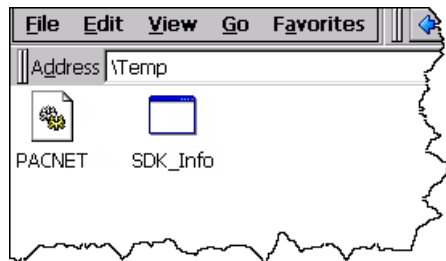

### 4.3.6. Execute the application on XP-8000-CE6

After uploading the application to XP-8000-CE6, you can just double-click it on XP-8000-CE6 to execute it.

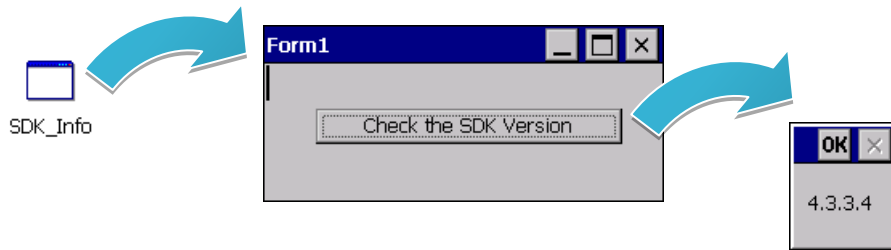

## 4.4. First XP-8000-CE6 Program in Visual C++

The best way to learn programming with XP-8000-CE6 is to actually create a XP-8000-CE6 program.

The example below demonstrates how to create a demo program running on XP-8000-CE6 with Visual C++.

To create a demo program with Visual C# that includes the following main steps:

1. Create a new project
2. Configure the Platform
3. Include the Header files and Libraries of the PAC SDK
4. Add the control to the form
5. Add the event handling for the control
6. Upload the application to XP-8000-CE6
7. Execute the application on XP-8000-CE6

All main steps will be described in the following subsection.

In this tutorial, we will assume that you have installed XP-8000-CE6 SDK on PC and used the Visual Studio 2008 for application development.

#### 4.4.1. Create a new project

The Visual C# project template is a composite control that you use in this example creates a new project with this user control.

##### Step 1: Start Visual Studio 2008



##### Step 2: On the File menu, point to New, and then click Project

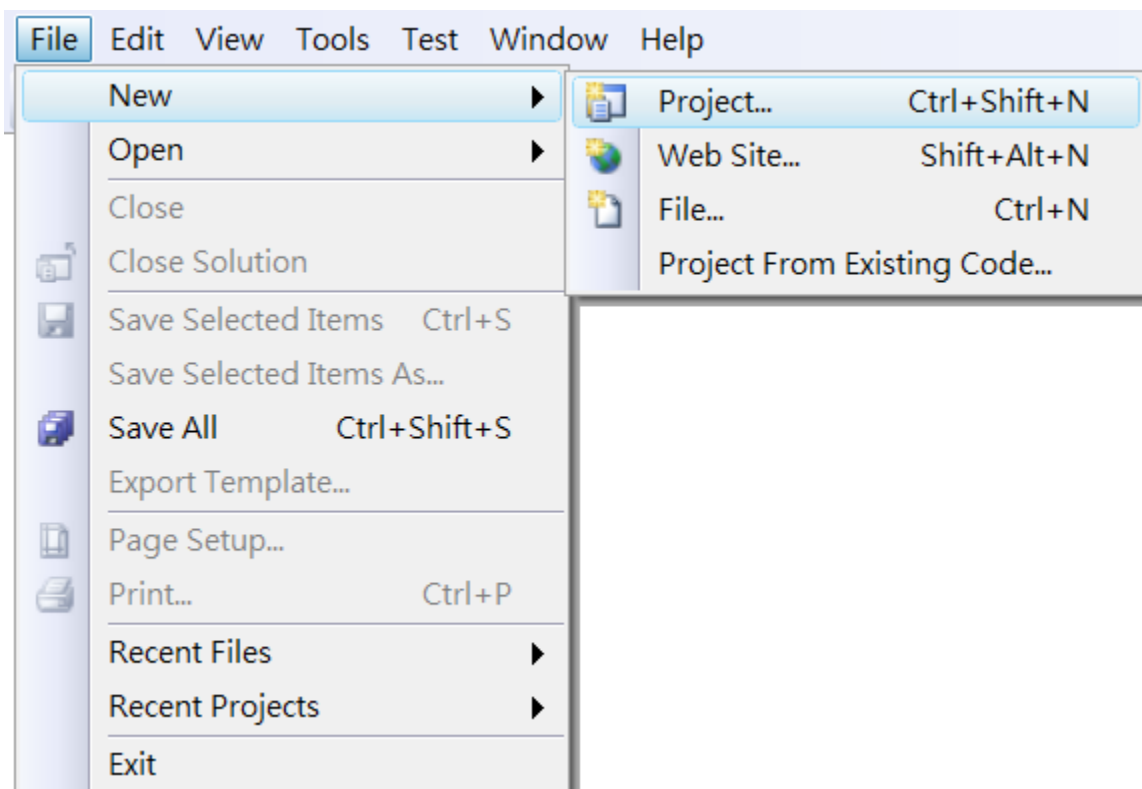

**Step 3:** In the Project types pane, expand Visual C++ node and select Smart Device

**Step 4:** In the list of Templates, select MFC Smart Device Application

**Step 5:** Specify a name and a location for the application and then click OK

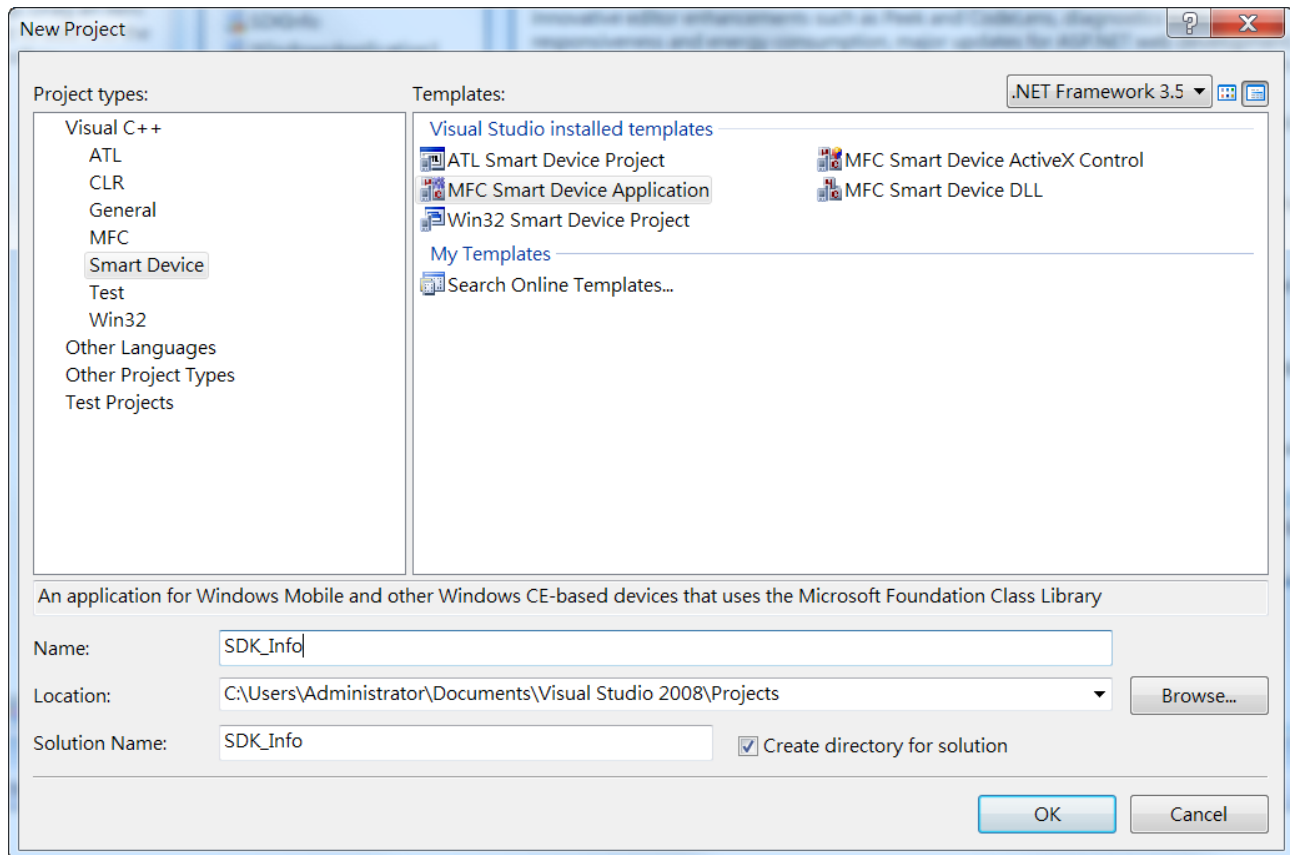



**Step 6: On the first page of the wizard, click Next**

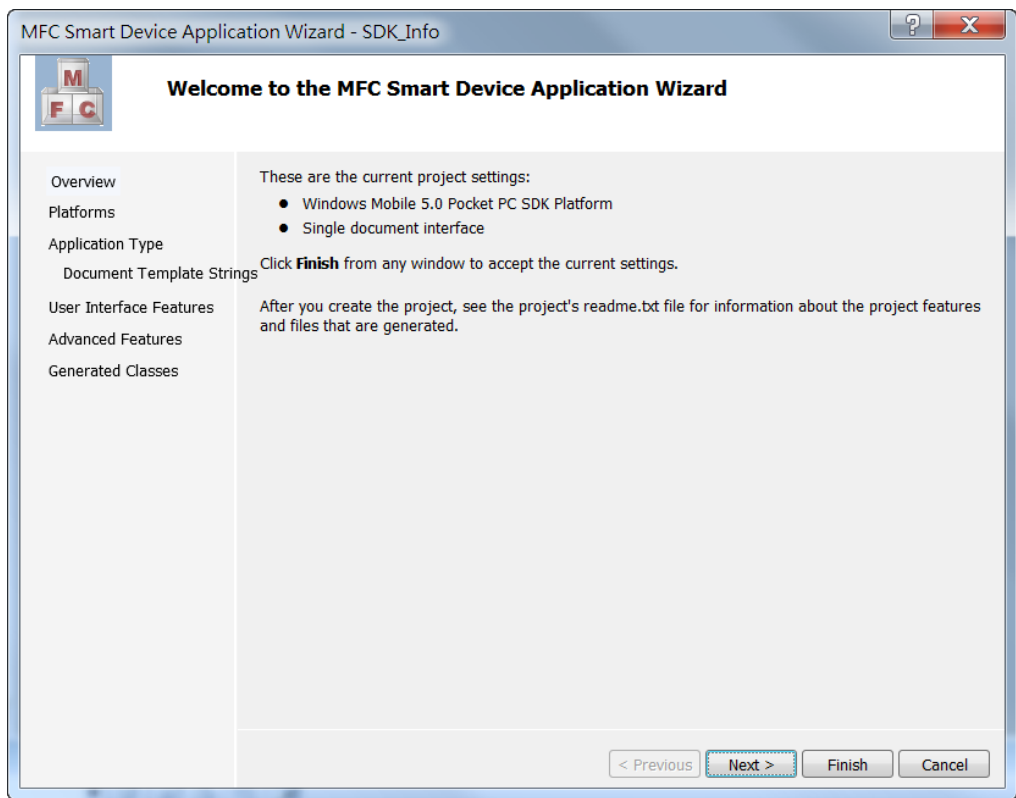

**Step 7: On the next page of the wizard, select XPacSDK\_CE to be added to the project, and then click Next**

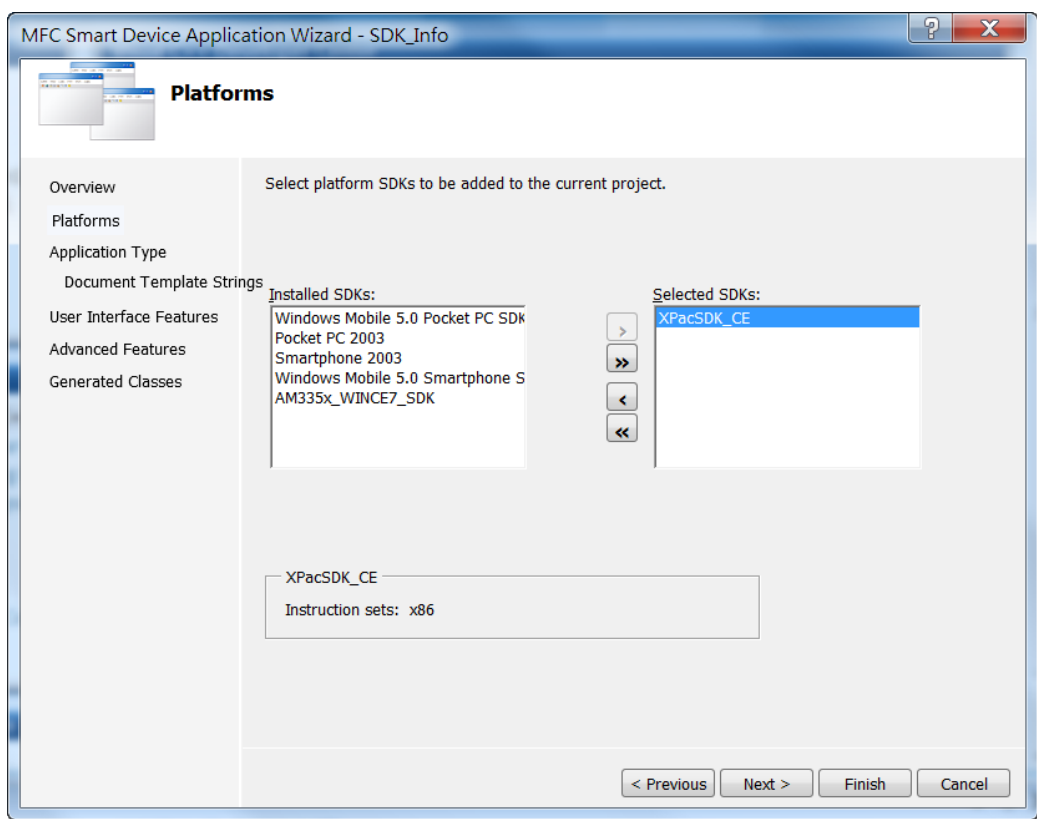

**Step 8: On the next page of the wizard, select Dialog based, and then click next**

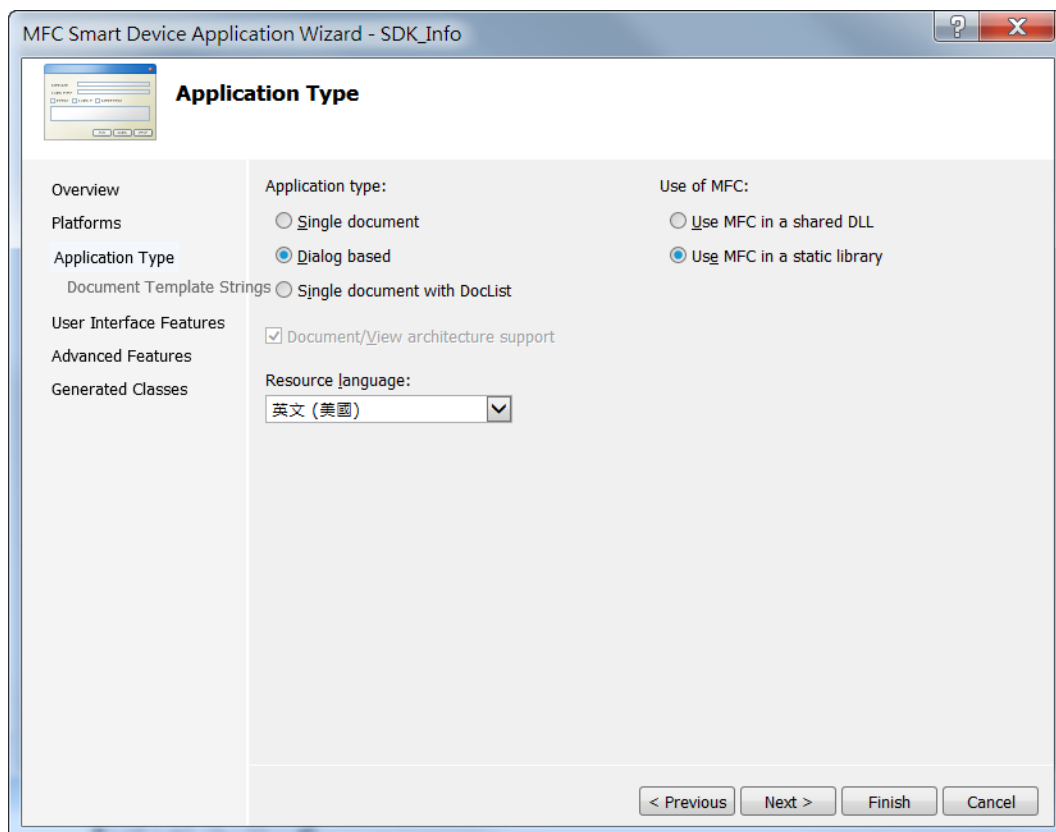

**Step 9: On the next page of the wizard, click next**

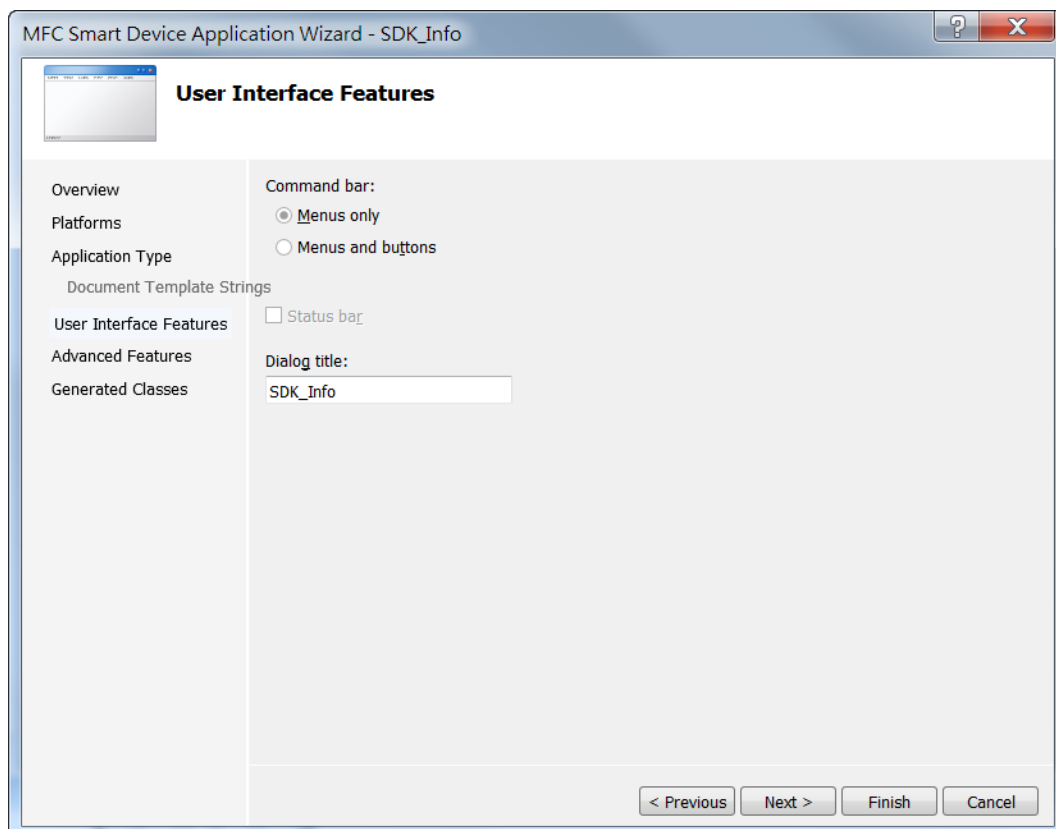

**Step 10: On the next page of the wizard, click next**

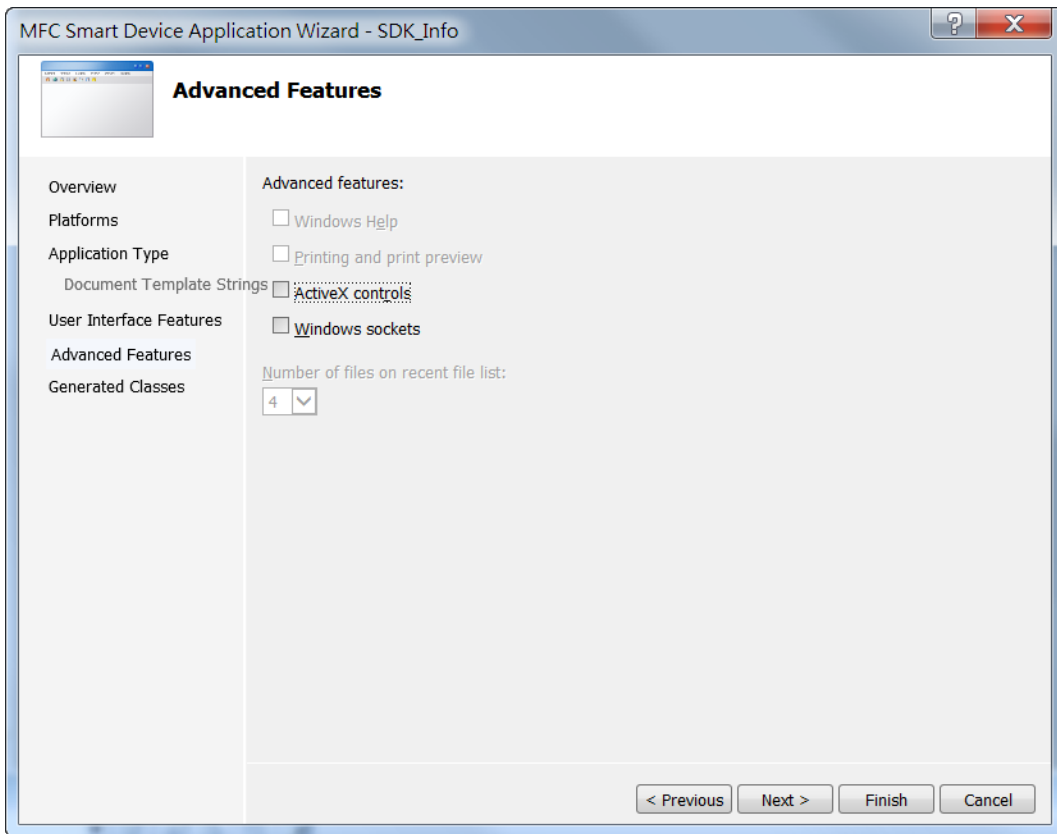

**Step 11: On the next page of the wizard, click Finish**

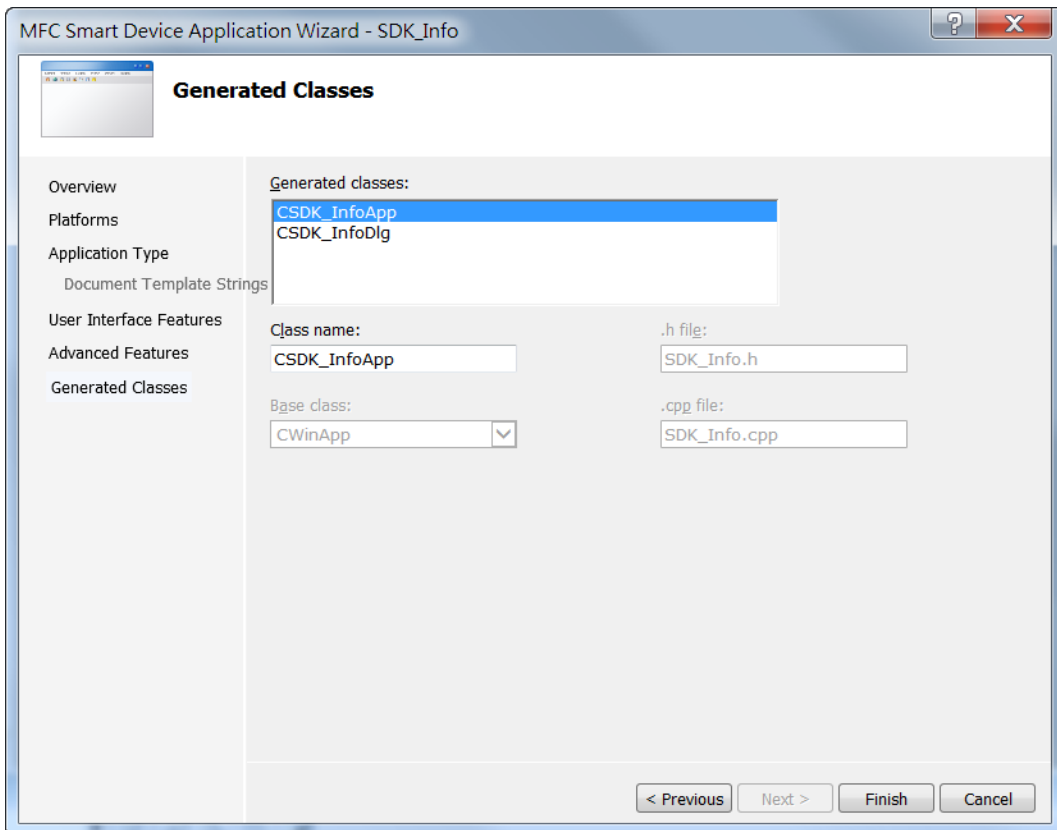

## 4.4.2. Configure the Platform

When developing applications by using Visual C++, you must configure the Platform to indicate what platform and device you intend to download the application to. Before you deploy your project, check the platform.

On the Debug configuration toolbar, select Release and select XPacSDK\_CE(x86) as shown in the following illustration.

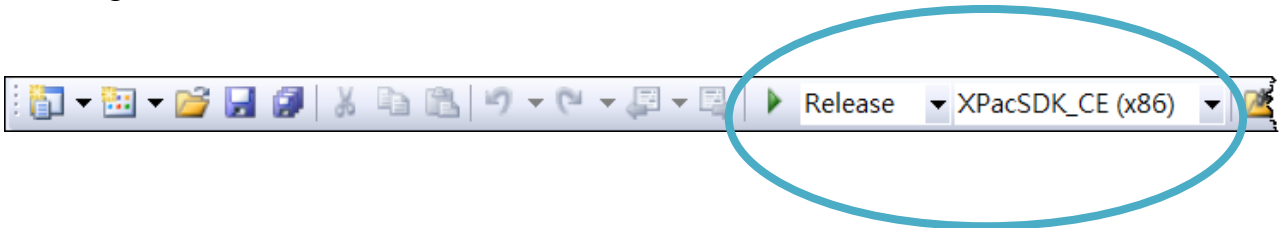

### 4.4.3. Specify the Libraries of the PAC SDK

The PAC SDK provides the PACSDK libraries with XP-8000-CE6.

It's compatible with C++. In order to use a component in your application, you must first add a reference to it.

#### Step 1: On the View menu, and then click Property Pages

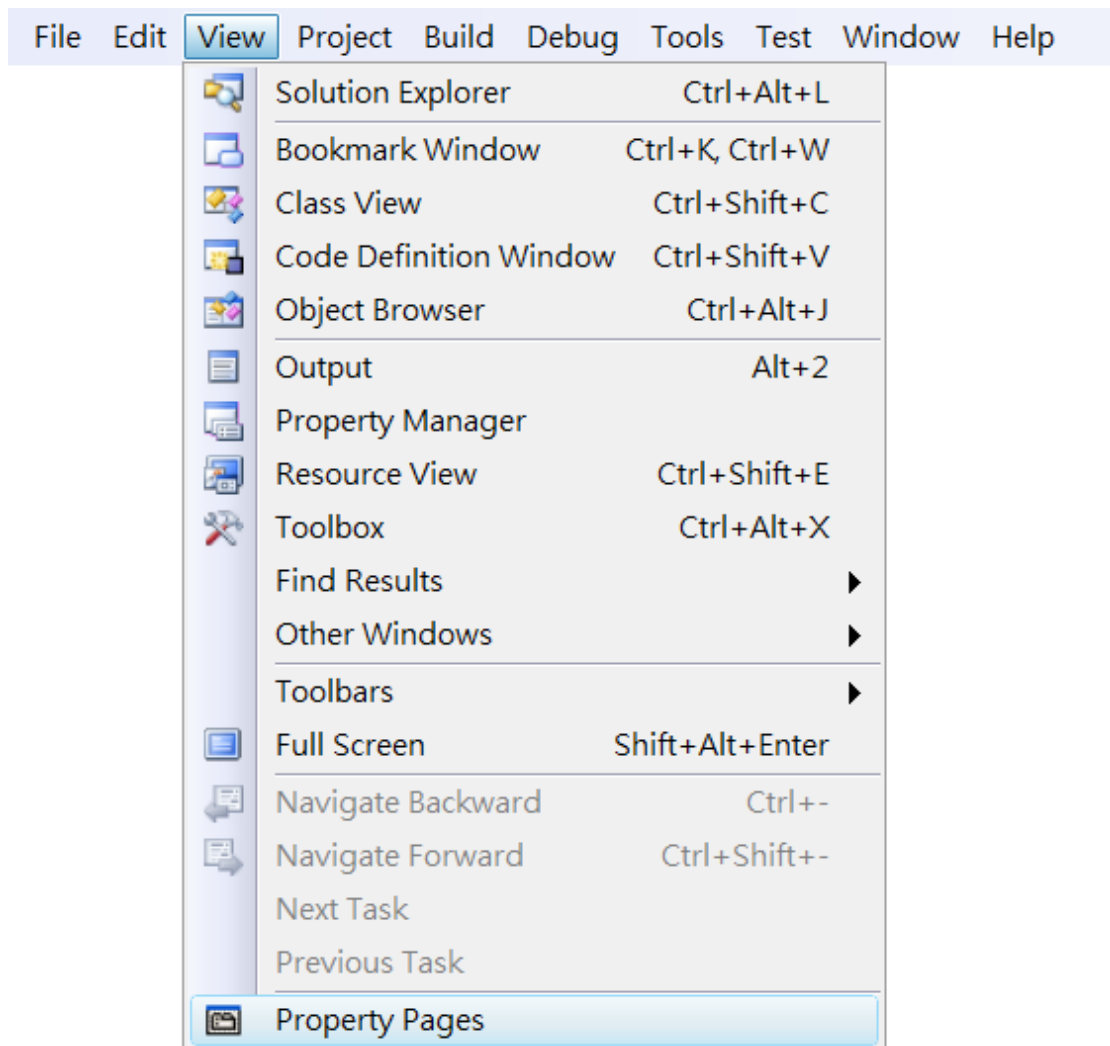

**Step 2: In left pane, click Linker, and then click Input**

**Step 3: In the right pane, Type PACSDK.lib in the Additional Dependencies item**

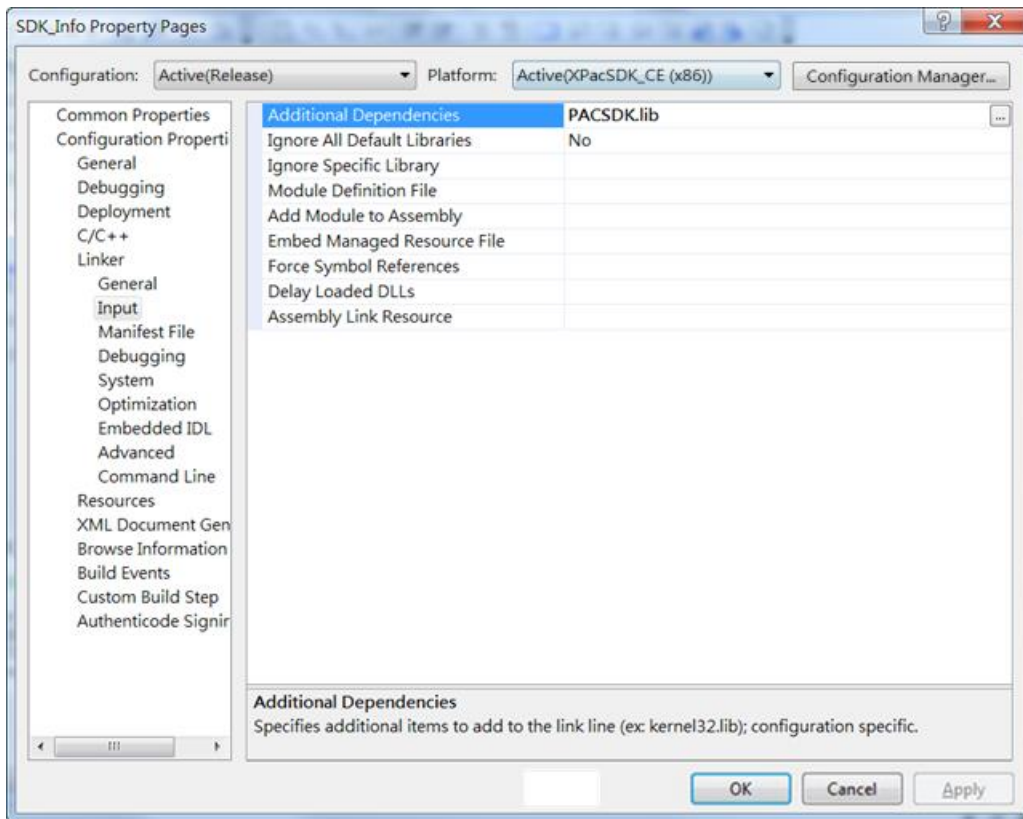

#### 4.4.4. Add the control to the form

You can drag various controls from the Toolbox onto the form. These controls are not really "live"; they are just images that are convenient to move around on the form into a precise location.

After you add a control to your form, you can use the Properties window to set its properties, such as background color and default text. The values that you specify in the Properties window are the initial values that will be assigned to that property when the control is created at run time.

#### Step 1: On the View menu, and then click Resource View

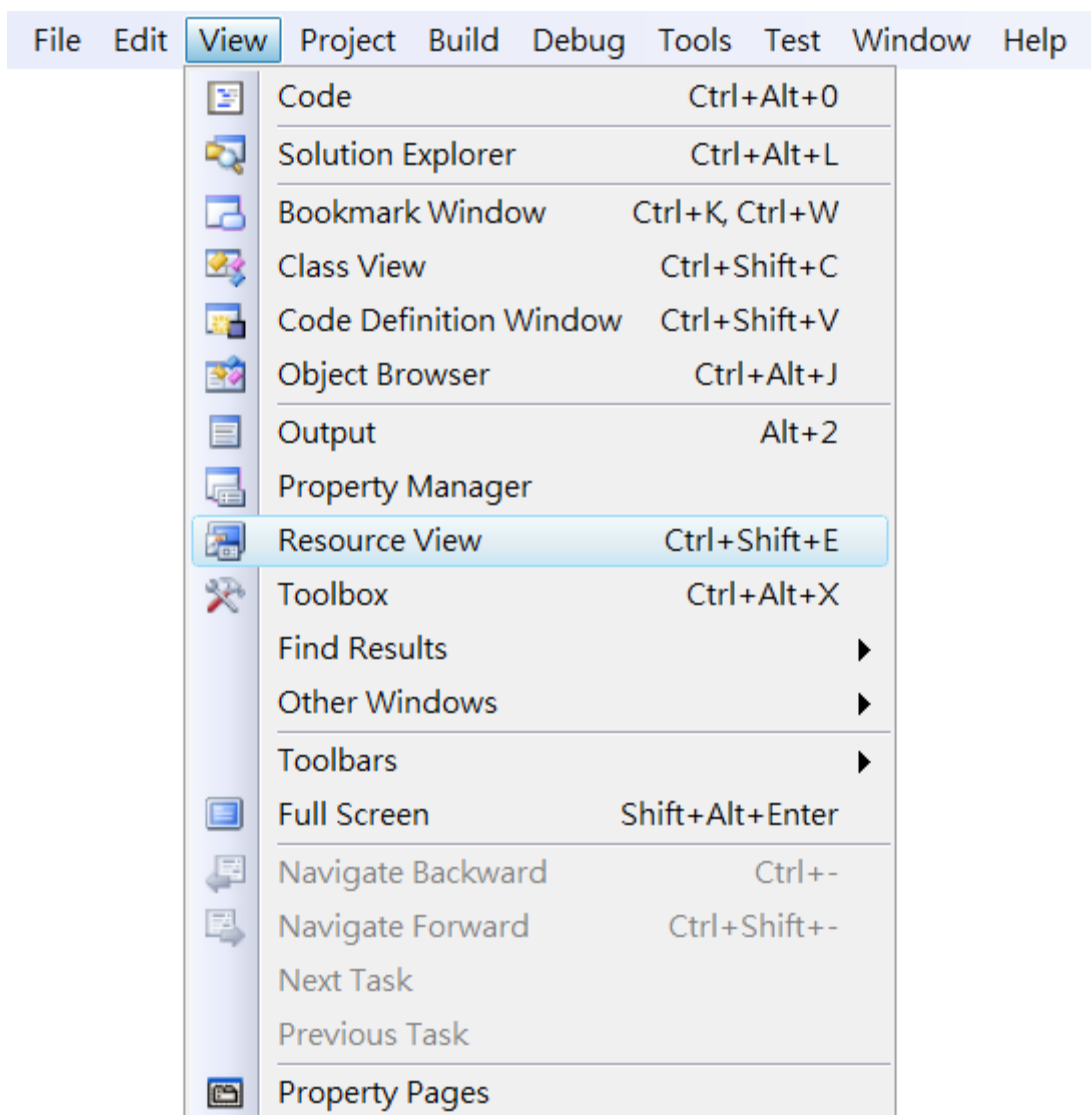

**Step 2: In the Resource View Panel, Expand the [Project name].rc file and then expand the Dialog item to click the plug-in dialog**

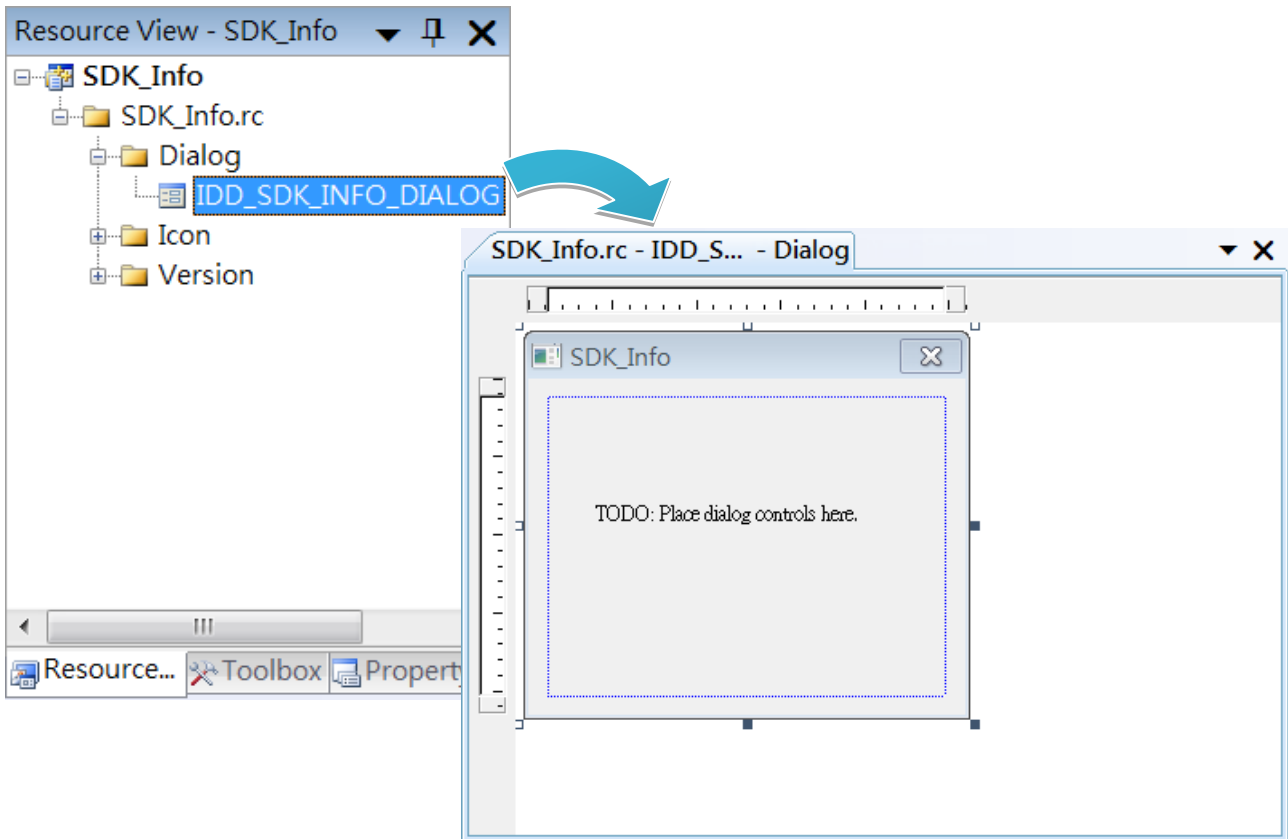

**Step 3: On the Toolbox panel, drag a Button control onto the form**

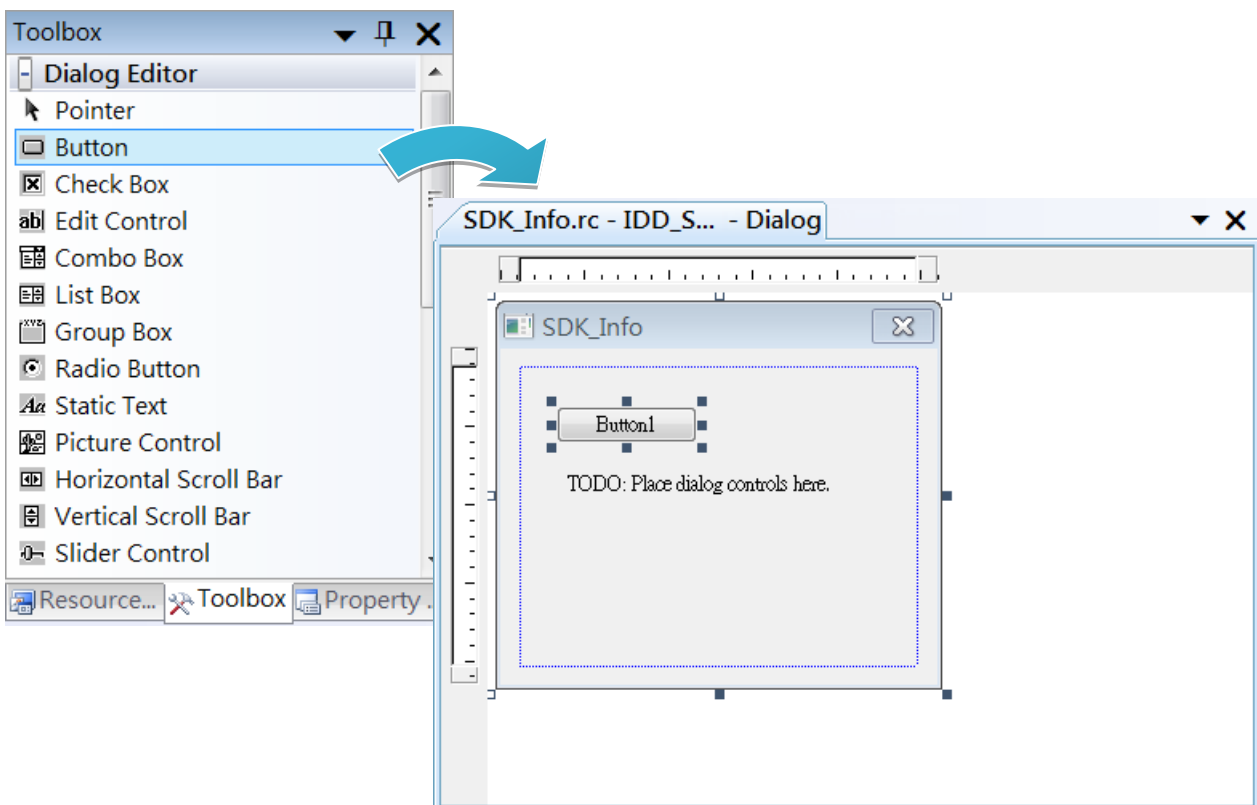



**Step 4: On the Properties panel, type Check the SDK version in the Caption field**

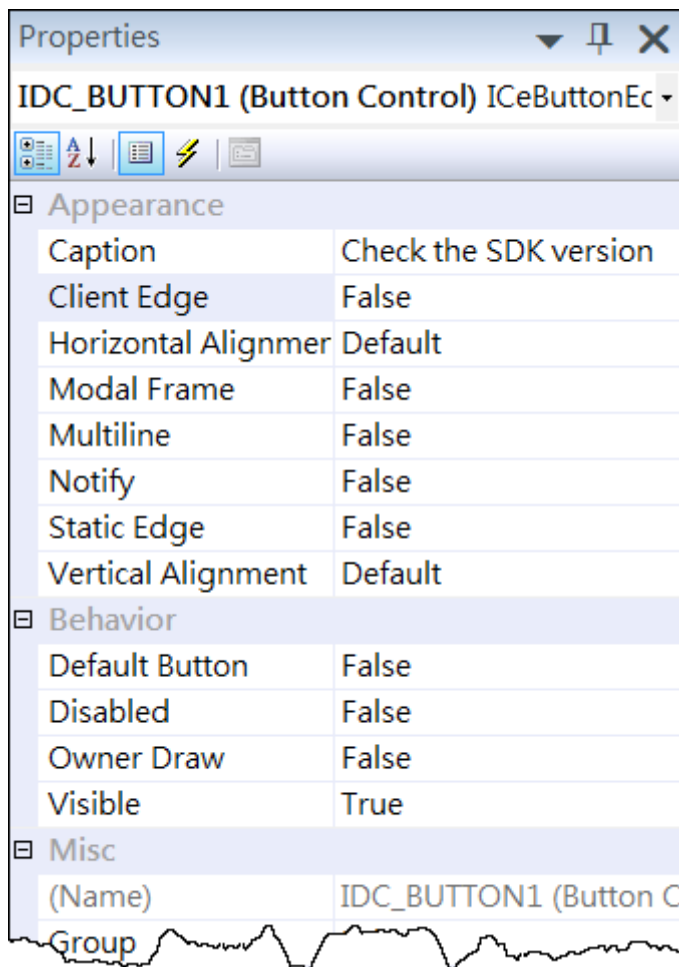

#### 4.4.5. Add the event handling for the control

You have finished the design stage of your application and are at the point when you can start adding some code to provide the program's functionality.

##### Step 1: Double-click the button on the form



##### Step 2: Inserting the following code

```
char sdk_version[32];  
TCHAR buf[32];  
pac_GetSDKVersion(sdk_version);  
pac_AnsiToWideString(sdk_version, buf);  
MessageBox(buf,0,MB_OK);
```



## Step 2: Inserting the following code into the header area

```
#include "PACSDK.h"
```

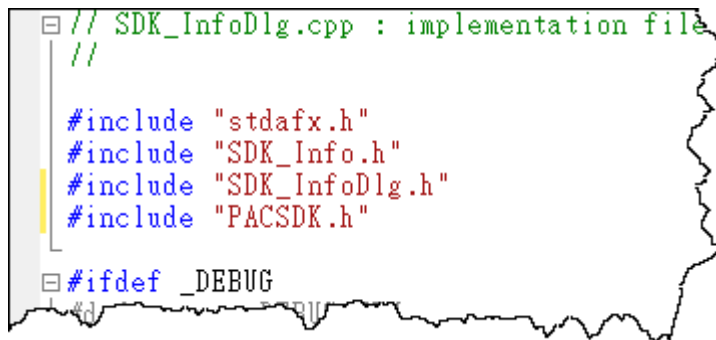

```
// SDK_InfoDlg.cpp : implementation file
//
#include "stdafx.h"
#include "SDK_Info.h"
#include "SDK_InfoDlg.h"
#include "PACSDK.h"
#ifdef _DEBUG
```

#### 4.4.6. Upload the application to XP-8000-CE6

XP-8000-CE6 supports FTP server service. You can upload files to XP-8000-CE6 or download files from a public FTP server.

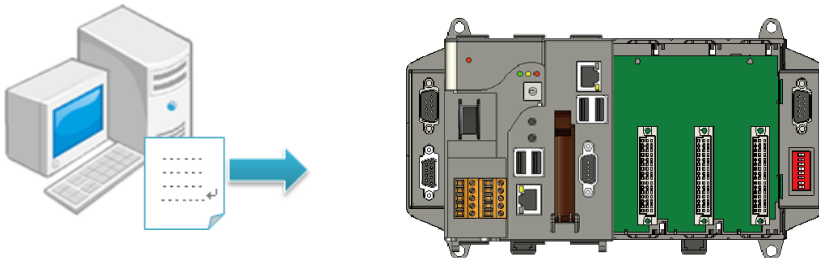

**Step 1: On the Build menu, and then click Build [Project Name]**

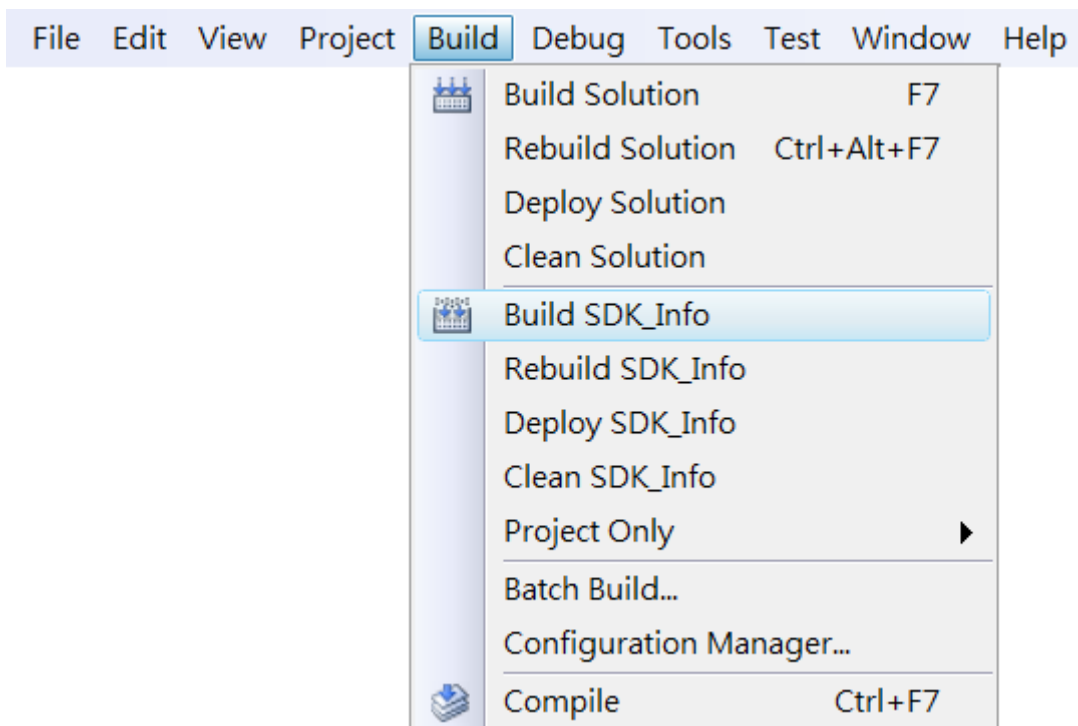

**Step 2: Open the browser and type the IP address of XP-8000-CE6**

**Step 3: Upload the application to XP-8000-CE6**

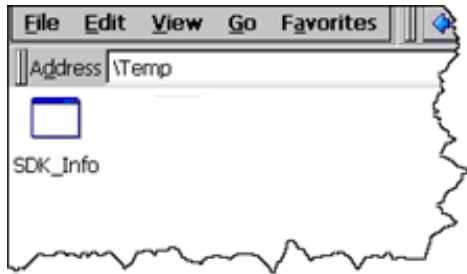

#### 4.4.7. Execute the application on XP-8000-CE6

After uploading the application to XP-8000-CE6, you can just double-click it on XP-8000-CE6 to execute it.

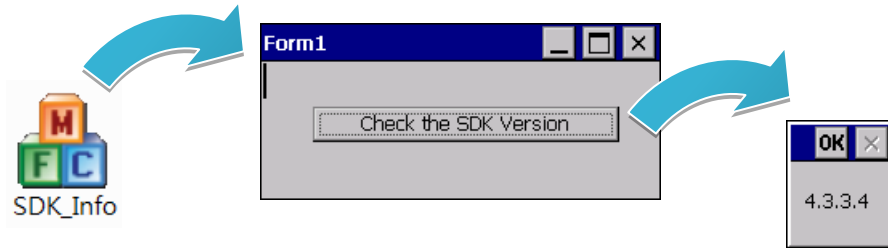

# 5. I/O Expansion Modules and SDKs Selection

This chapter describes how to select a suitable expansion I/O module and the corresponding SDK library to be used for developing programs on XP-8000-CE6.

XP-8000-CE6 provides the following I/O expansion buses:

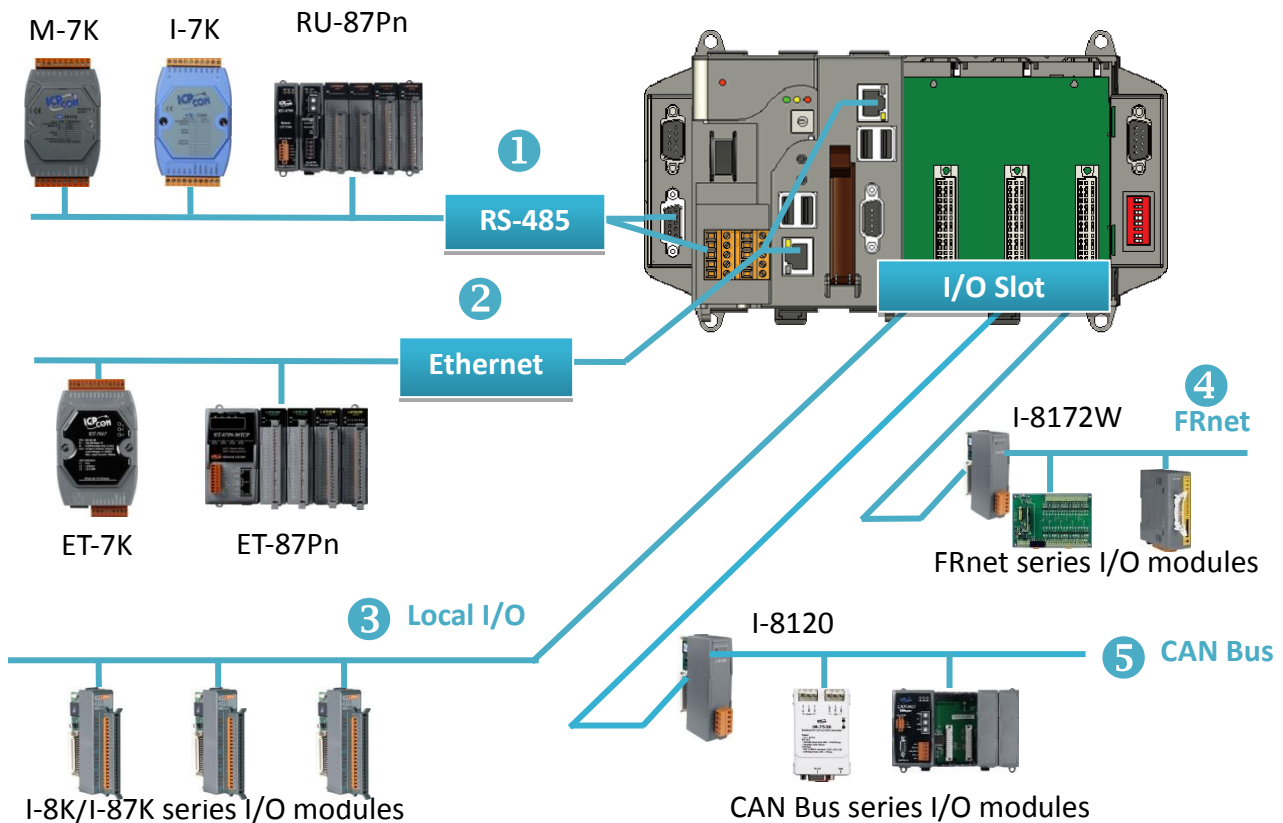

## 1. RS-485

I-7000, M-7000, RU-87Pn and high profile I-87K series modules connect to XP-8000-CE6 via a twisted-pair, multi-drop, 2-wire RS-485 network.

### ➤ I-7000 series I/O module

| Module                        | Native SDK     | .NET CF SDK |
|-------------------------------|----------------|-------------|
| I-7000 series                 | PACSDK.dll     | PACNET.dll  |
| I-7000 series with I-7088 (D) | PACSDK_PWM.dll | PACNET.dll  |

For full details regarding I-7000 series I/O modules and its demos, please refer to:

[http://ftp.icpdas.com/pub/cd/xp-8x3x-ce6/demo/xpac/applicable\\_demo\\_for\\_7k\\_module.pdf](http://ftp.icpdas.com/pub/cd/xp-8x3x-ce6/demo/xpac/applicable_demo_for_7k_module.pdf)

### ➤ M-7000 series I/O module

| Module        | Native SDK  | .NET CF SDK |
|---------------|-------------|-------------|
| M-7000 series | Modbus Demo | Modbus Demo |

For more detailed information about M-7000 series modules using Modbus protocol and its demos, please refer to:

<http://ftp.icpdas.com/pub/cd/xp-8x3x-ce6/demo/nmodbus/>

### ➤ RU-87Pn + I-87K series I/O module

| Module               | Native SDK | .NET CF SDK |
|----------------------|------------|-------------|
| RU-87Pn+I-87K series | PACSDK.dll | PACNET.dll  |

### ➤ Other Specified I/O

| Module | Native SDK | .NET CF SDK |
|--------|------------|-------------|
| Others | PACSDK.dll | PACNET.dll  |



## 2. Ethernet

The Ethernet I/O devices available include ET-7000 and I-8KE4/8-MTCP, and support either the DCON or the Modbus/TCP communication protocol.

| Module        | Native SDK  | .NET CF SDK |
|---------------|-------------|-------------|
| M-7000 series | Modbus Demo | Modbus Demo |
| I-8KE4/8-MTCP | Modbus Demo | Modbus Demo |

For more detailed information about ET-7000 and I-8KE4/8-MTCP series modules using Modbus protocol and its demos, please refer to:

<http://ftp.icpdas.com/pub/cd/xp-8x3x-ce6/demo/nmodbus/>

## 3. Local I/O

XP-8000-CE6 has 0/1/3/7 expansion slot(s) that can be used to add expansion I/O modules. The expansion I/O modules can be divided into two categories: High Profile I-8K series I/O modules and High profile I-87K series I/O modules. The following indicates the appropriate SDK library to be used for I/O modules.

### ➤ General I-8K/I-87K series I/O module

| Module       | Native SDK | .NET CF SDK |
|--------------|------------|-------------|
| I-8K series  | PACSDK.dll | PACNET.dll  |
| I-87K series | PACSDK.dll | PACNET.dll  |

For full details regarding I-87K series I/O modules and its demos, please refer to:

[http://ftp.icpdas.com/pub/cd/xp-8x3x-ce6/demo/xpac/applicable\\_demo\\_for\\_87k\\_module.pdf](http://ftp.icpdas.com/pub/cd/xp-8x3x-ce6/demo/xpac/applicable_demo_for_87k_module.pdf)

➤ **Other Specified I/O**

| Module   | Native SDK      | .NET CF SDK        |
|----------|-----------------|--------------------|
| I-8014W  | pac_i8014W.dll  | pac_i8014WNET.dll  |
| I-8017HW | pac_i8017HW.dll | pac_i8017HWNET.dll |
| I-8024W  | pac_i8024W.dll  | pac_i8024WNET.dll  |
| I-8026W  | pac_i8026W.dll  | pac_i8026WNET.dll  |
| I-8048W  | pac_i8048W.dll  | pac_i8048WNET.dll  |
| I-8050W  | pac_i8050W.dll  | pac_i8050WNET.dll  |
| I-8084W  | pac_i8084W.dll  | pac_i8084WNET.dll  |
| I-8088W  | pac_i8088W.dll  | pac_i8088WNET.dll  |
| I-8093W  | pac_i8093W.dll  | pac_i8093WNET.dll  |
| I-87088W | PACSDK_PWM.dll  | PACNET.dll         |

**4. FRnet**

FRnet is an innovative industrial field bus technology that uses twisted pair cable as the transmission medium. The status of all I/O devices is updated on a fixed cycle, no matter how many FRnet I/O modules are connected to the FRnet network.

| Module  | Native SDK     | .NET CF SDK     |
|---------|----------------|-----------------|
| I-8172W | pac_i8172W.lib | pac8172WNet.dll |

**5. CAN Bus**

The Controller Area Network (CAN) is a serial communication way, which efficiently supports distributed real-time control with a very high level of security. It provides the error-processing mechanisms and concepts of message priority. These features can improve the network reliability and transmission efficiency.

| Module  | Native SDK | .NET CF SDK      |
|---------|------------|------------------|
| I-8120W | i8120.lib  | i8120net_pac.dll |

## 6. APIs and Demo References

This chapter provides a brief overview of PAC standard APIs and demos that have been designed for XP-8000-CE6 from the PAC SDK package.

ICP DAS provides a set of demos in different programming languages. You can examine the demo codes, which includes numerous comments, to familiarize yourself with the PAC APIs. This will allow developing your own applications quickly by modifying these demo programs.

For full usage information regarding the description, prototype and the arguments of the functions, please refer to the “PAC Standard API Manual”

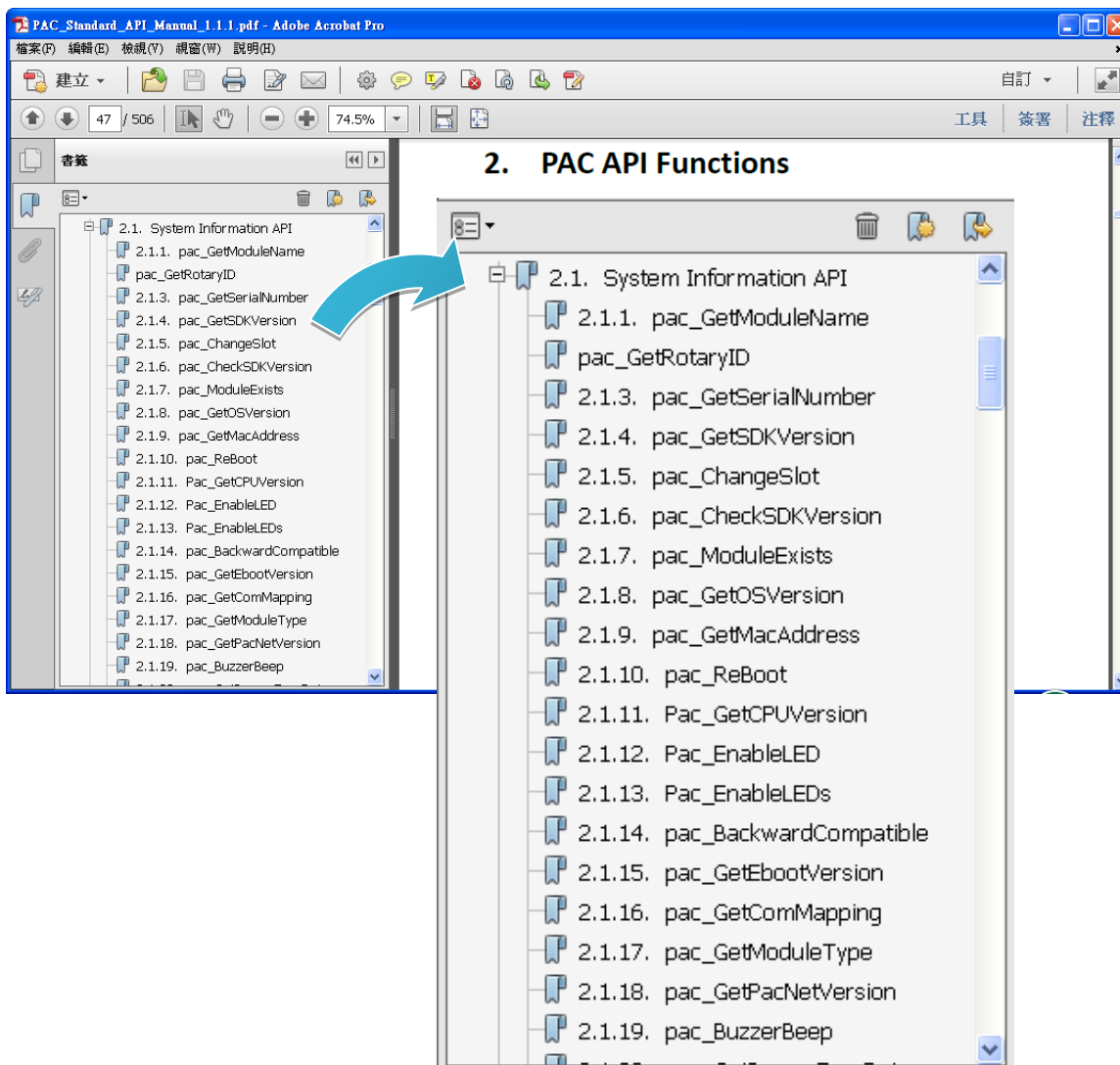

## 6.1. PAC Standard APIs for System Operation

The diagram below shows the set of each system operation API provided in the PACSDK.

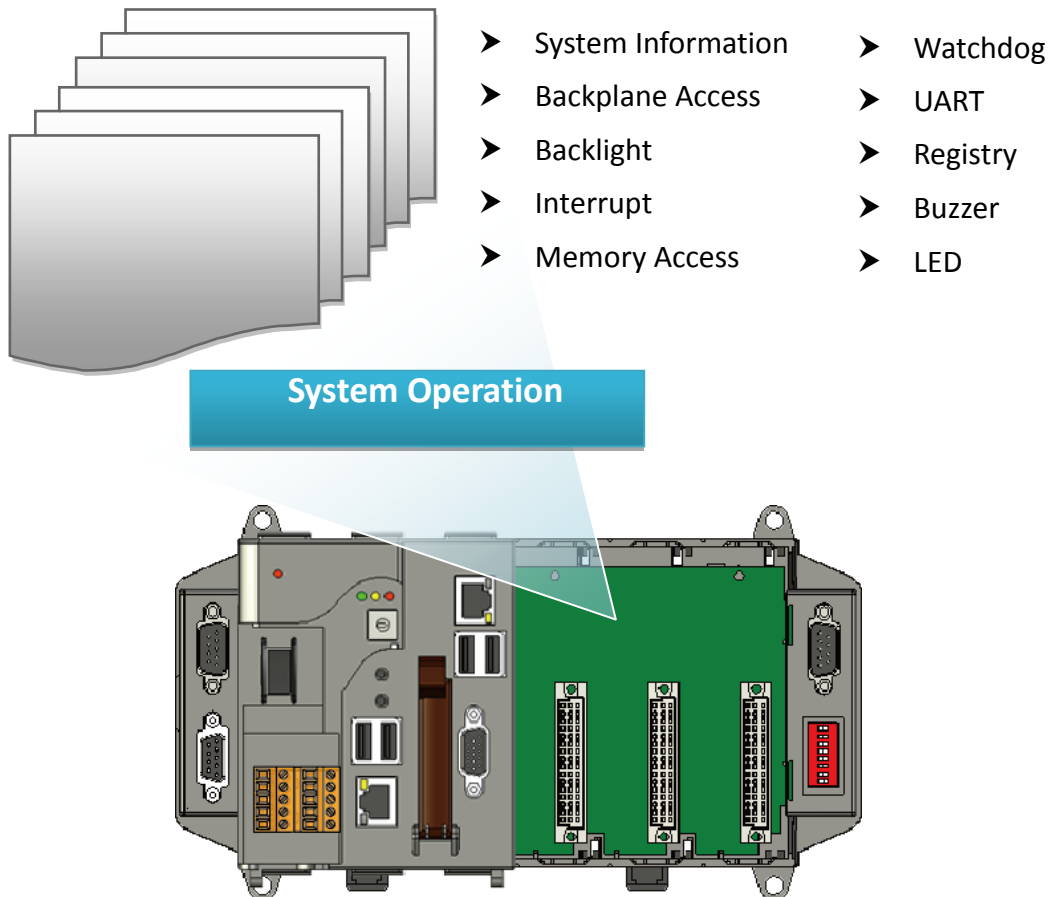

### 6.1.1. VB.NET Demos for PAC Standard APIs

The PAC SDK includes the following demos that demonstrate the use of the PAC Standard APIs in a VB.NET language environment.

The following demos can be found on the CD that was provided with the package or by downloading the latest version from ICP DAS web site.

CD:\XP-8X3X-CE6\demo\XPAC\VB.NET\Standard\

<http://ftp.icpdas.com/pub/cd/xp-8x3x-ce6/demo/xpac/vb.net/standard/>

| Folder            | Demo              | Explanation   |
|-------------------|-------------------|---|
| BPtimer           | BPtimer           | Retrieves information about the hardware timer.   |
| DeviceInformation | DeviceInformation | Retrieves information about the OS version, CPU version, SDK version, etc.                                    |
| Diagnostic        | Diagnostic        | Retrieves information about the slot count and the module inserted in the backplane.                          |
| DIP               | DIP               | Retrieves information about the status of the DIP switch.   |
| GetRotaryID       | GetRotaryID       | Retrieves information about the status of the rotary switch.  |
| Memory            | Memory            | Shows how to read/write data values from/to the EEPROM or the backplane of the SRAM                           |
| RealTimeTest      | RealTimeTest      | Writes the managed cod for the rich graphical user interface that does not require true real-time performance |
| Registry          | Registry          | Shows how to read/write data values from/to the registry.   |
| UART              | UART              | Shows how to read the name of the local I/O module via a UART.  |
| WatchDog          | WatchDog          | Displays information about how to operate the watchdog.   |

## 6.1.2. C# Demos for PAC Standard APIs

The PAC SDK includes the following demos that demonstrate the use of the PAC Standard APIs in a C# language environment.

The following demos can be found on the CD that was provided with the package or by downloading the latest version from ICP DAS web site.

CD:\XP-8X3X-CE6\demo\XPAC\C#\Standard\

<http://ftp.icpdas.com/pub/cd/xp-8x3x-ce6/demo/xpac/c%23/standard/>

| Folder            | Demo              | Explanation  |
|-------------------|-------------------|--|
| BPtimer           | BPtimer           | Retrieves information about the hardware timer.  |
| DeviceInformation | DeviceInformation | Retrieves information about the OS version, CPU version, SDK version, etc.                                     |
| Diagnostic        | Diagnostic        | Retrieves information about the slot count and the module inserted in the backplane.                           |
| DIP               | DIP               | Retrieves information about the status of the DIP switch.  |
| GetRotaryID       | GetRotaryID       | Retrieves information about the status of the rotary switch.   |
| Memory            | Memory            | Shows how to read/write data values from/to the EEPROM or the backplane of the SRAM                            |
| RealTimeTest      | RealTimeTest      | Writes the managed code for the rich graphical user interface that does not require true real-time performance |
| Registry          | Registry          | Shows how to read/write data values from/to the registry.  |
| UART              | UART              | Shows how to read the name of the local I/O module via a UART.   |
| WatchDog          | WatchDog          | Displays information about how to operate the watchdog.  |

### 6.1.3. Visual C++ Demos for PAC Standard APIs

The PAC SDK includes the following demos that demonstrate the use of the PAC Standard APIs in a Visual C++ language environment.

The following demos can be found on the CD that was provided with the package or by downloading the latest version from ICP DAS web site.

CD:\XP-8X3X-CE6\demo\XPAC\VC2005\Standard\

<http://ftp.icpdas.com/pub/cd/xp-8x3x-ce6/demo/xpac/vc2005/standard/>

| Folder            | Demo              | Explanation  |
|-------------------|-------------------|--|
| BPtimer           | BPtimer           | Retrieves information about the hardware timer.  |
| DeviceInformation | DeviceInformation | Retrieves information about the OS version, CPU version, SDK version, etc.                                     |
| Diagnostic        | Diagnostic        | Retrieves information about the slot count and the module inserted in the backplane.                           |
| DIP               | DIP               | Retrieves information about the status of the DIP switch.  |
| GetRotaryID       | GetRotaryID       | Retrieves information about the status of the rotary switch.   |
| Memory            | Memory            | Shows how to read/write data values from/to the EEPROM or the backplane of the SRAM                            |
| RealTimeTest      | RealTimeTest      | Writes the managed code for the rich graphical user interface that does not require true real-time performance |
| Registry          | Registry          | Shows how to read/write data values from/to the registry.  |
| UART              | UART              | Shows how to read the name of the local I/O module via a UART.   |
| WatchDog          | WatchDog          | Displays information about how to operate the watchdog.  |

## 6.2. PAC Standard APIs for PAC Expansion I/O

The diagram below shows the types of the PAC IO APIs provided in the PACSDK.

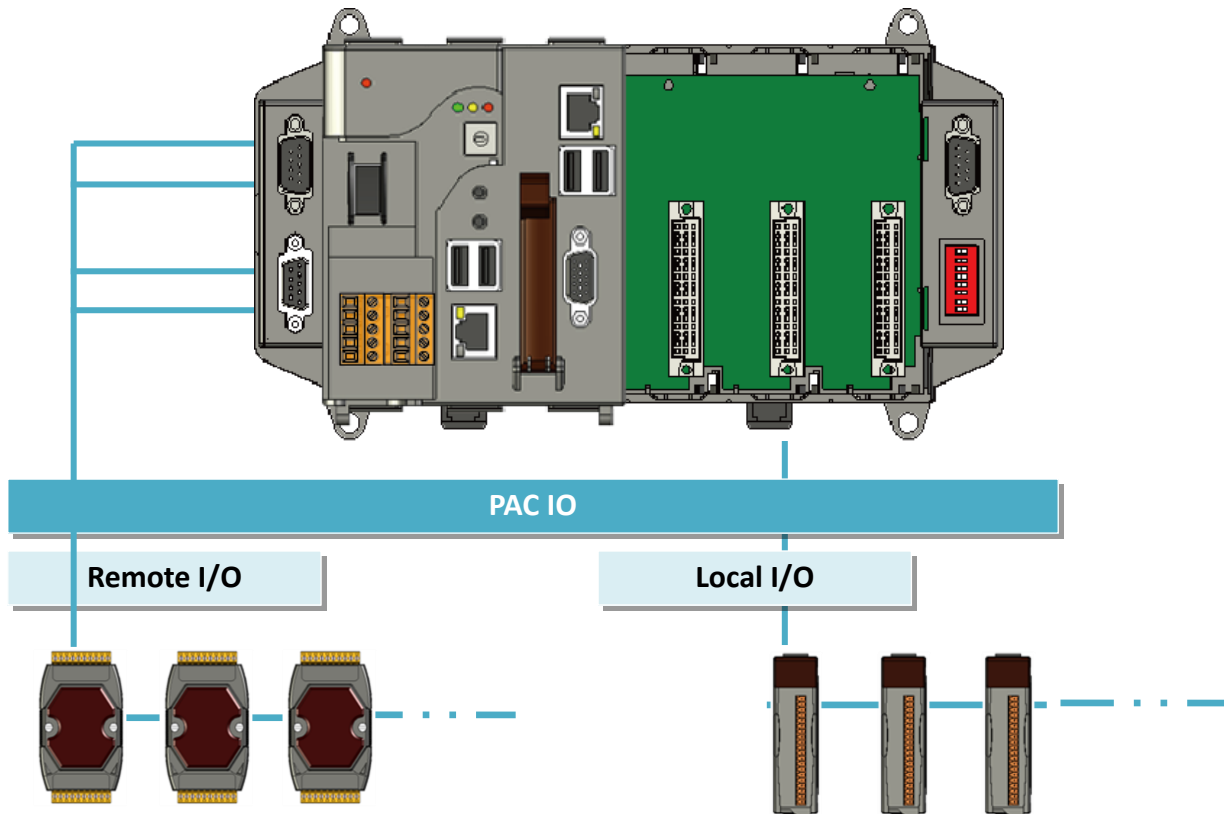



## 6.2.1. VB.net Demos for PAC Expansion I/O

The PAC SDK includes the following demos that demonstrate the use of the PAC expansion I/O in a VB.NET language environment.

The following demos can be found on the CD that was provided with the package or by downloading the latest version from ICP DAS web site.

CD:\XP-8X3X-CE6\demo\XPAC\VB.NET\IO\

<http://ftp.icpdas.com/pub/cd/xp-8x3x-ce6/demo/xpac/vb.net/io/>

| Folder | Demo        | Explanation   |
|--------|-------------|---|
| Local  | find_io     | Shows how to retrieve the module name and type which plugged in the XP-8000-CE6.  |
|        | 8k_di       | Shows how to read the DI values of DI module.<br>This demo program is used by 8K series DI modules.   |
|        | 8k_do       | Shows how to write the DO values to DO module.<br>This demo program is used by 8K series DO modules.  |
|        | 8k_dio      | Shows how to read the DI and the DO values of the DIO module.<br>This demo program is used by 8K series DIO modules.                                      |
|        | 87k_basic   | Shows how to send/receive a command/response application.<br>This demo program is used by 87K series modules.   |
|        | 87K_demo    | Shows how use uart API and the IO modules located as slots.<br>This demo program is used by 87K series modules.   |
|        | 87k_ai      | Shows how to read the AI values of AI module.<br>This demo program is used by 87K series AI modules.  |
|        | 87k_ao      | Shows how to write the AO values to AO module.<br>This demo program is used by 87K series AO modules.   |
|        | 87k_di      | Shows how to read the DI values of DI module.<br>This demo program is used by 87K series DI modules.  |
| Local  | 87k_do      | Shows how to write the DO values to DO module.<br>This demo program is used by 87K series DO modules.   |
|        | 87k_dio     | Shows how to read the DI and the DO values of the DIO module.<br>This demo program is used by 87K series DIO modules.                                     |
| Remote | 7k87k_basic | Shows how to send/receive a command/response application.<br>This demo program is used by 7K or 87K series AI modules which connected through a COM port. |

| Folder | Demo      | Explanation   |
|--------|-----------|---|
|        | 7k87k_ai  | Shows how to read the AI values of AI module.<br>This demo program is used by 7K or 87K series AI modules which connected through a COM port.                 |
|        | 7k87k_ao  | Shows how to write the AO values to AO module.<br>This demo program is used by 7K or 87K series AI modules which connected through a COM port.                |
|        | 7k87k_di  | Shows how to read the DI values of DI module.<br>This demo program is used by 7K or 87K series AI modules which connected through a COM port.                 |
|        | 7k87k_do  | Shows how to write the DO values to DO module.<br>This demo program is used by 7K or 87K series AI modules which connected through a COM port.                |
|        | 7k87k_dio | Shows how to read the DI and the DO values of the DIO module.<br>This demo program is used by 7K or 87K series AI modules which connected through a COM port. |

## 6.2.2. C# Demos for PAC Expansion I/O

The PAC SDK includes the following demos that demonstrate the use of the PAC expansion I/O in a C# language environment.

The following demos can be found on the CD that was provided with the package or by downloading the latest version from ICP DAS web site.

CD:\XP-8X3X-CE6\demo\XPAC\C#\IO\

<http://ftp.icpdas.com/pub/cd/xp-8x3x-ce6/demo/xpac/c%23io/>

| Folder | Demo        | Explanation   |
|--------|-------------|---|
| Local  | find_io     | Shows how to retrieve the module name and type which plugged in the XP-8000-CE6.  |
|        | 8k_di       | Shows how to read the DI values of DI module.<br>This demo program is used by 8K series DI modules.   |
|        | 8k_do       | Shows how to write the DO values to DO module.<br>This demo program is used by 8K series DO modules.  |
|        | 8k_dio      | Shows how to read the DI and the DO values of the DIO module.<br>This demo program is used by 8K series DIO modules.                                      |
|        | 87k_basic   | Shows how to send/receive a command/response application.<br>This demo program is used by 87K series modules.   |
|        | 87K_demo    | Shows how use uart API and the IO modules located as slots.<br>This demo program is used by 87K series modules.   |
|        | 87k_ai      | Shows how to read the AI values of AI module.<br>This demo program is used by 87K series AI modules.  |
|        | 87k_ao      | Shows how to write the AO values to AO module.<br>This demo program is used by 87K series AO modules.   |
|        | 87k_di      | Shows how to read the DI values of DI module.<br>This demo program is used by 87K series DI modules.  |
| Local  | 87k_do      | Shows how to write the DO values to DO module.<br>This demo program is used by 87K series DO modules.   |
|        | 87k_dio     | Shows how to read the DI and the DO values of the DIO module.<br>This demo program is used by 87K series DIO modules.                                     |
| Remote | 7k87k_basic | Shows how to send/receive a command/response application.<br>This demo program is used by 7K or 87K series AI modules which connected through a COM port. |

| Folder | Demo      | Explanation   |
|--------|-----------|---|
|        | 7k87k_ai  | Shows how to read the AI values of AI module.<br>This demo program is used by 7K or 87K series AI modules which connected through a COM port.                 |
|        | 7k87k_ao  | Shows how to write the AO values to AO module.<br>This demo program is used by 7K or 87K series AI modules which connected through a COM port.                |
|        | 7k87k_di  | Shows how to read the DI values of DI module.<br>This demo program is used by 7K or 87K series AI modules which connected through a COM port.                 |
|        | 7k87k_do  | Shows how to write the DO values to DO module.<br>This demo program is used by 7K or 87K series AI modules which connected through a COM port.                |
|        | 7k87k_dio | Shows how to read the DI and the DO values of the DIO module.<br>This demo program is used by 7K or 87K series AI modules which connected through a COM port. |

### 6.2.3. Visual C++ Demos for PAC Expansion I/O

The PAC SDK includes the following demos that demonstrate the use of the PAC expansion I/O in a C# language environment.

The following demos can be found on the CD that was provided with the package or by downloading the latest version from ICP DAS web site.

CD:\XP-8X3X-CE6\demo\XPAC\VC2005\IO\

<http://ftp.icpdas.com/pub/cd/xp-8x3x-ce6/demo/xpac/vc2005/io/>

| Folder | Demo        | Explanation   |
|--------|-------------|---|
| Local  | find_io     | Shows how to retrieve the module name and type which plugged in the XP-8000-CE6.  |
|        | 8k_di       | Shows how to read the DI values of DI module.<br>This demo program is used by 8K series DI modules.   |
|        | 8k_do       | Shows how to write the DO values to DO module.<br>This demo program is used by 8K series DO modules.  |
|        | 8k_dio      | Shows how to read the DI and the DO values of the DIO module.<br>This demo program is used by 8K series DIO modules.                                      |
|        | 87k_basic   | Shows how to send/receive a command/response application.<br>This demo program is used by 87K series modules.   |
|        | 87K_demo    | Shows how use uart API and the IO modules located as slots.<br>This demo program is used by 87K series modules.   |
|        | 87k_ai      | Shows how to read the AI values of AI module.<br>This demo program is used by 87K series AI modules.  |
|        | 87k_ao      | Shows how to write the AO values to AO module.<br>This demo program is used by 87K series AO modules.   |
|        | 87k_di      | Shows how to read the DI values of DI module.<br>This demo program is used by 87K series DI modules.  |
| Local  | 87k_do      | Shows how to write the DO values to DO module.<br>This demo program is used by 87K series DO modules.   |
|        | 87k_dio     | Shows how to read the DI and the DO values of the DIO module.<br>This demo program is used by 87K series DIO modules.                                     |
| Remote | 7k87k_basic | Shows how to send/receive a command/response application.<br>This demo program is used by 7K or 87K series AI modules which connected through a COM port. |

| Folder | Demo      | Explanation   |
|--------|-----------|---|
|        | 7k87k_ai  | Shows how to read the AI values of AI module.<br>This demo program is used by 7K or 87K series AI modules which connected through a COM port.                 |
|        | 7k87k_ao  | Shows how to write the AO values to AO module.<br>This demo program is used by 7K or 87K series AI modules which connected through a COM port.                |
|        | 7k87k_di  | Shows how to read the DI values of DI module.<br>This demo program is used by 7K or 87K series AI modules which connected through a COM port.                 |
|        | 7k87k_do  | Shows how to write the DO values to DO module.<br>This demo program is used by 7K or 87K series AI modules which connected through a COM port.                |
|        | 7k87k_dio | Shows how to read the DI and the DO values of the DIO module.<br>This demo program is used by 7K or 87K series AI modules which connected through a COM port. |

## 7. Recovery and Restore

This chapter provides information of the XP-8000-CE6 restore and recovery, and a guided tour that describes the steps needed to restore and recovery the XP-8000-CE6.

The XP-8000-CE6 comes with a rescue CF card that can be used to not only boot the XP-8000-CE6 when the OS fails to load, but also recover files.

The recovery file of the rescue CF card can be found separately on the CD that was provided with the package or by downloading the latest version from ICP DAS web site.

CD:\XP-8X3X-CE6\Rescue\_Disk\

[http://ftp.icpdas.com/pub/cd/xp-8x3x-ce6/rescue\\_disk/](http://ftp.icpdas.com/pub/cd/xp-8x3x-ce6/rescue_disk/)

## 7.1. Recovering the XP-8000-CE6

If the XP-8000-CE6 crashes and won't start up, you can use the rescue CF card to start up the XP-8000-CE6 and then fix the problem that caused the crash.

### Step 1: Plug the CF card in CF slot and turn the rotary switch in position 0

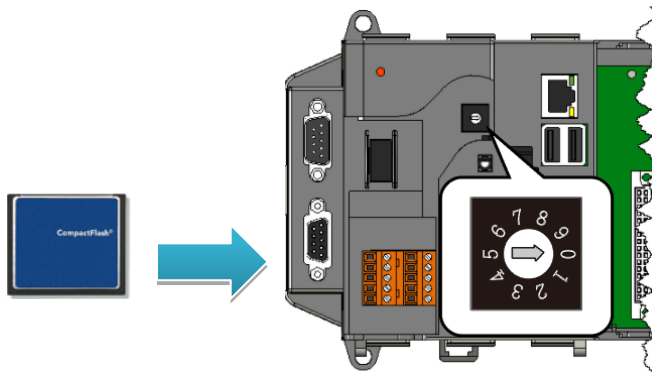

### Step 2: Reboot the XP-8000-CE6, press Delete key to enter the BIOS setup utility

### Step 3: On the Boot menu, select Hard Disk Drives and then press Enter key

| BIOS SETUP UTILITY          |          |        |      |          |                    |      |
|-----------------------------|----------|--------|------|----------|--------------------|------|
| Main                        | Advanced | PCIPnP | Boot | Security | Chipset            | Exit |
| Boot Settings               |          |        |      |          | Specifies the Boot |      |
| Boot Settings Configuration |          |        |      |          | Device Priority    |      |
| Hard Disk Drives            |          |        |      |          | sequence from      |      |
|                             |          |        |      |          | available Hard     |      |
|                             |          |        |      |          | drives             |      |



**Step 4: Select 1st Drive and then press Enter key**

**Step 5: Set 1st Drive as HDD: PM-CF Card, it means the XP-8000-CE6 booting from the CF card**

| BIOS SETUP UTILITY |          |        |                       |          |   |      |
|--------------------|----------|--------|-----------------------|----------|---|------|
| Main               | Advanced | PCIPnP | Boot                  | Security | Chipset   | Exit |
| Hard Disk Drivers  |          |        |                       |          | Specifies the Boot sequence from available drives |      |
| 1st Drive          |          |        | [HDD: PM-CF Card]     |          |   |      |
| 2nd Drive          |          |        | [SATA: SM-8GB SATA F] |          |   |      |

**Step 6: Press F10 key and select OK to exit the setup utility and reboot the XP-8000-CE6**

After rebooting the XP-8000-CE6, the system will enter the XP-8000-CE6 Rescue Utility.

## Step 7: Enter 1, (1) create XPAC\_CE default partition

Wait a while until we enter the XP-8000-CE6 Rescue Utility again.

```
=====
==                               ==
Main Menu
=====

**   the following 3 steps help you   **
**   restore default XPAC_CE OS.     **

(1) Step 1: create XPAC_CE default partition.
(2) Step 2: format and restore XPAC_CE to factory default OS.
(3) Step 3: reboot

(6) Display directory information on built-in flash

Please enter your choice: 1
```

## Step 8: Enter 2, (2) format and restore XPAC\_CE to factory default OS.

Wait a while until we enter the XP-8000-CE6 Rescue Utility again.

```
=====
==                               ==
Main Menu
=====

**   the following 3 steps help you   **
**   restore default XPAC_CE OS.     **

(1) Step 1: create XPAC_CE default partition.
(2) Step 2: format and restore XPAC_CE to factory default OS.
(3) Step 3: reboot

(6) Display directory information on built-in flash

Please enter your choice: 2
```

## Step 9: Enter 3, (3) reboot

```
=====
==                               ==
=====

**  the following 3 steps help you  **
**  restore default XPAC_CE OS.    **

(1) Step 1: create XPAC_CE default partition.
(2) Step 2: format and restore XPAC_CE to factory default OS.
(3) Step 3: reboot

(6) Display directory information on built-in flash

Please enter your choice: 3
```

## Step 10: Repeat step 2 to step 6 to set 1st Drive as SATA: SM-8GB SATA F

SATA: SM-8GB SATA F1 means Built-in flash.

| BIOS SETUP UTILITY |          |        |                       |          |   |      |
|--------------------|----------|--------|-----------------------|----------|---|------|
| Main               | Advanced | PCIPnP | Boot                  | Security | Chipset   | Exit |
| Hard Disk Drivers  |          |        |                       |          | Specifies the Boot sequence from available drives |      |
| 1st Drive          |          |        | [SATA: SM-8GB SATA F] |          |   |      |
| 2nd Drive          |          |        | [HDD: PM-CF Card]     |          |   |      |

## Step 11: The XP-8000-CE6 has been recovered

## 7.2. Restoring the Rescue CF Card

The rescue CF card is rescue equipment that allows you to perform some maintenance tasks on your system in case of failure.

Once the rescue CF card are partitioned or formatted, you must restore the rescue CF card.

### Requirements

For restoring the Rescue CF card, you should prepare Ghost 11 or later, which you could obtain by contacting Symantec (<http://www.symantec.com>)

Here are step by step instructions on how to restore the rescue CF card. In this demonstration, we will use Symantec Norton Ghost32 V.11.0 (The Symantec Norton Ghost V.11 or above version are recommend).

### Step 1: Get the latest version of rescue ghost file, rescue.gho

The latest version of rescue.gho file can be found by downloading the latest version from ICP DAS web site.

[http://ftp.icpdas.com/pub/cd/xp-8x3x-ce6/rescue\\_disk/](http://ftp.icpdas.com/pub/cd/xp-8x3x-ce6/rescue_disk/)

### Step 2: Start the Symantec Norton Ghost32 V.11, and then click OK

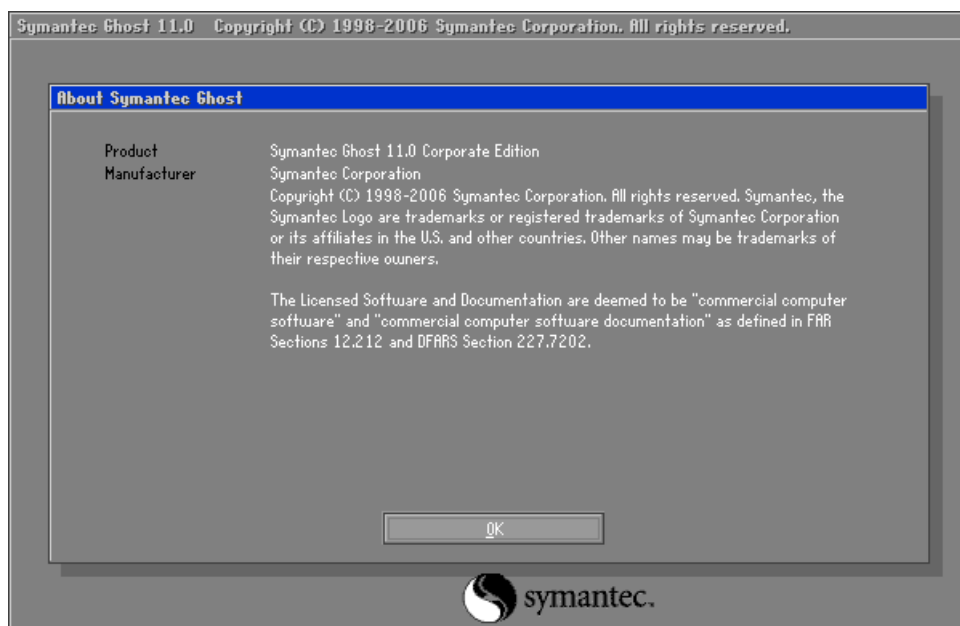

**Step 3: Click Function Menu, point to Local, point to Disk, and then click From Image**

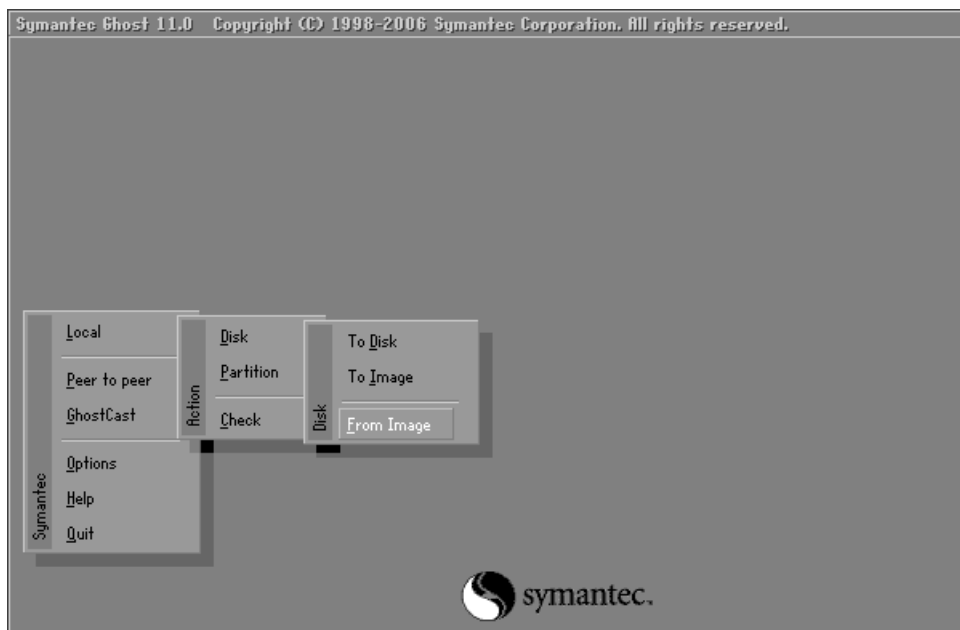

**Step 4: Select the rescue ghost file that you saved, and then click Open**

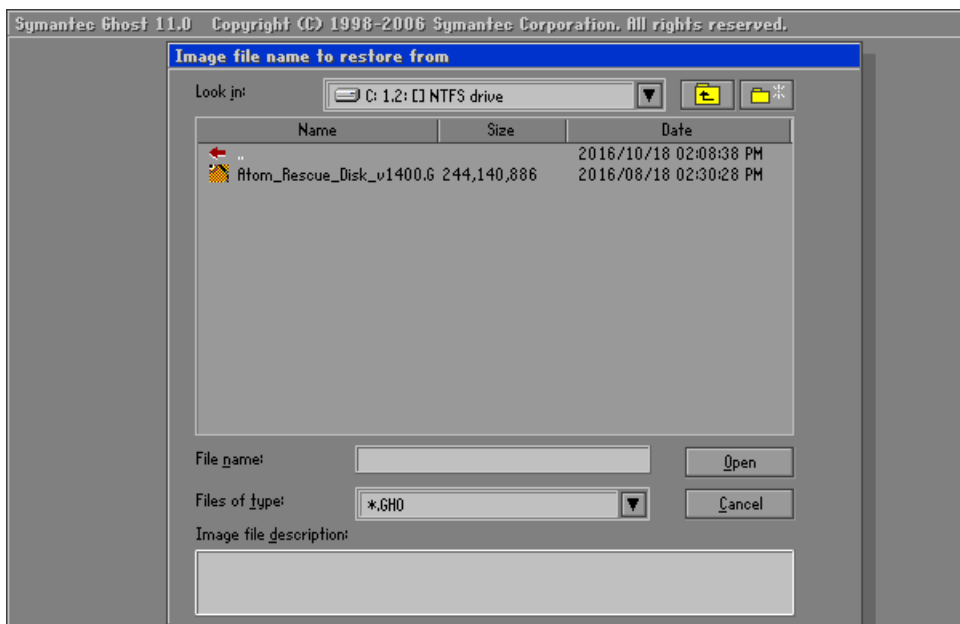

**Step 5: Select the destination to CF card and click then OK**

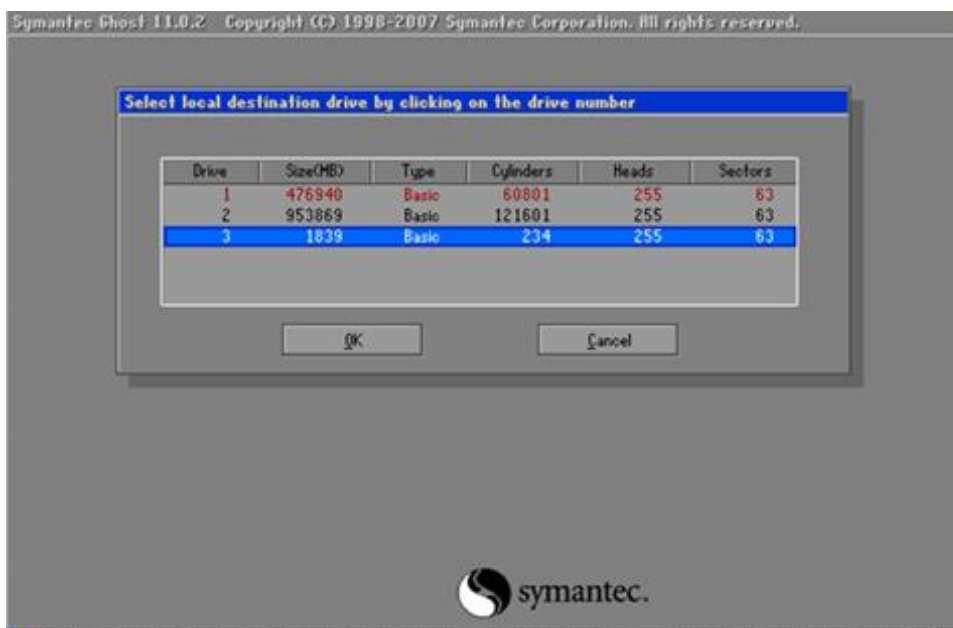

**Step 6: Recovery the rescue ghost file into CF card and then click OK**

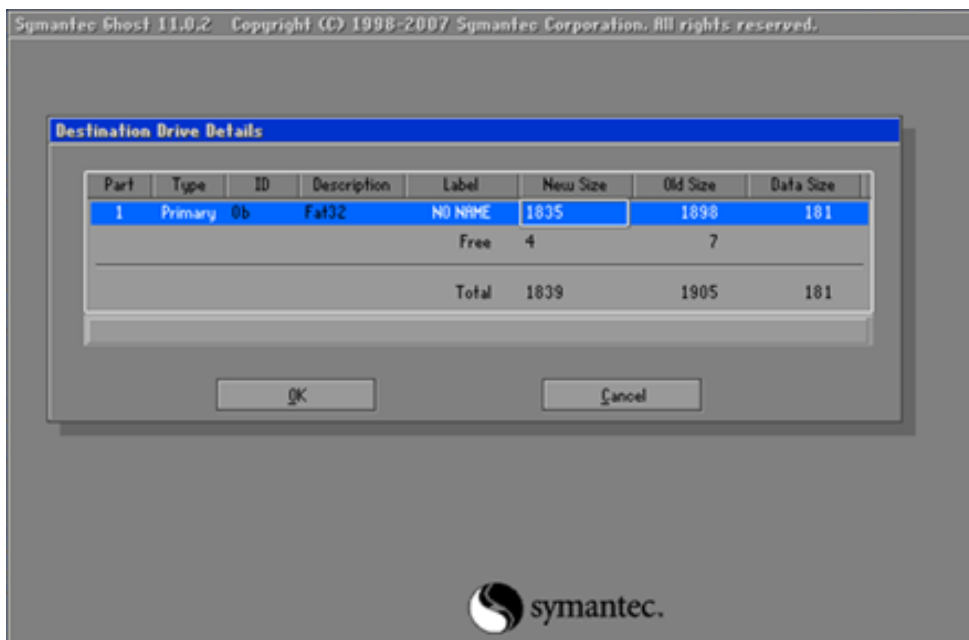

## Step 7: The rescue CF card has been done

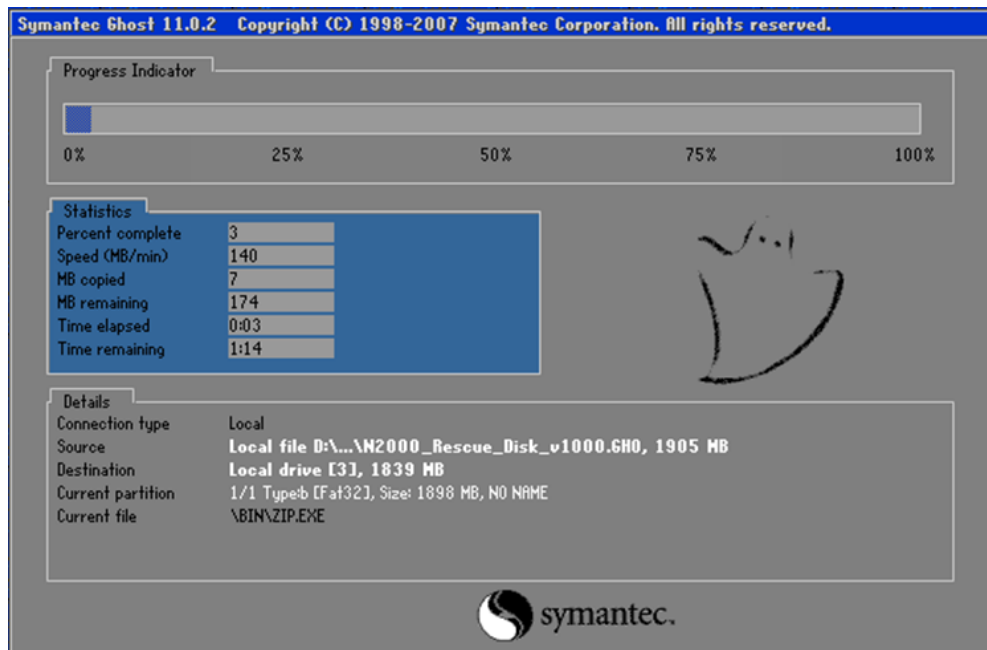

## 8. XP-8000-CE6 Updates

This chapter provides a guided tour that demonstrates the steps needed to update the XP-8000-CE6 OS and SDKs.

ICP DAS will continue to add additional features to XP-8000-CE6 SDK and OS in the future, so we advise you to periodically check the ICP DAS web site for the latest updates.

### The file location of the OS and SDK

Both the files of OS updates and SDK updates can be found on the CD that was provided with the package or by downloading the latest version from ICP DAS web site.

- For XP-8x31-CE6:  
CD:\XP-8X3X-CE6\  
<http://ftp.icpdas.com/pub/cd/xp-8x3x-ce6/>

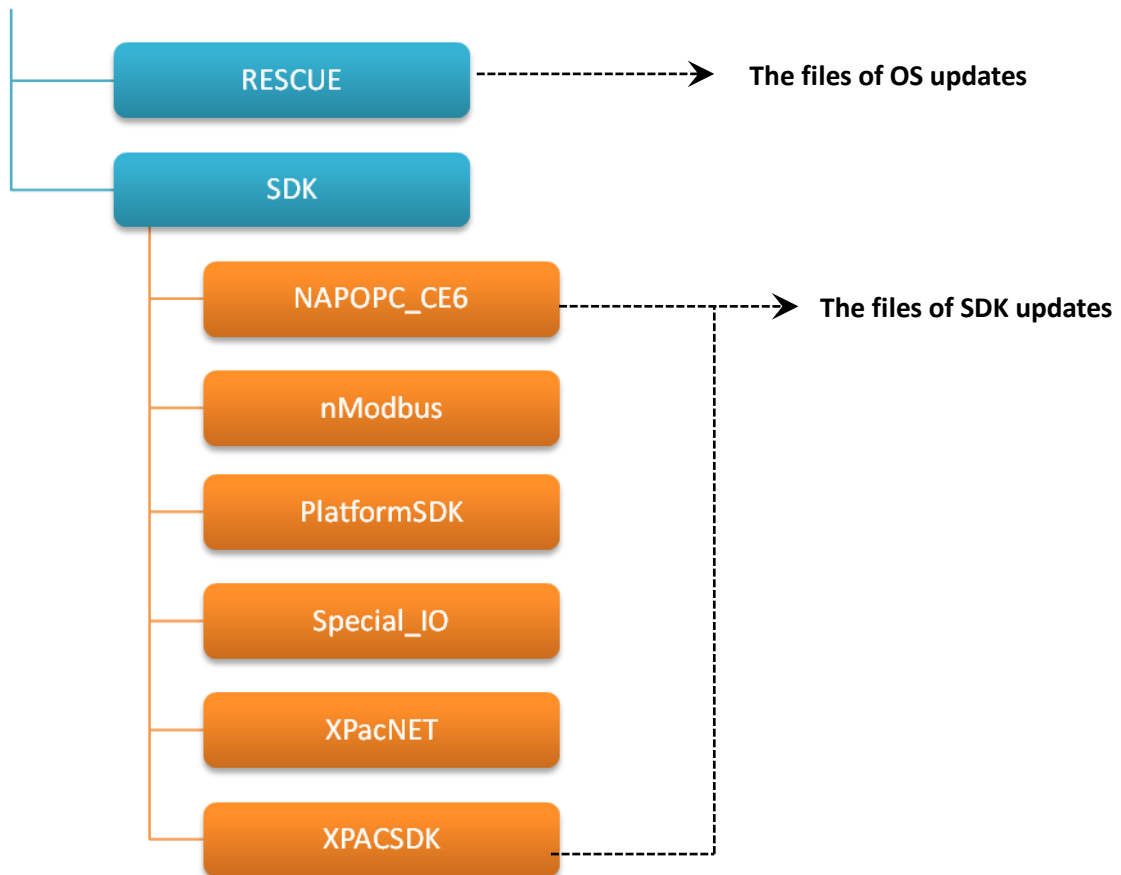



## 8.1. OS updates

OS updates are part of the XP-8000-CE6 updates services to provide additional and more efficient features and functionality for XP-8000-CE6 operating system.

There are two ways to update the OS:

1. Update from file (Please refer to section 8.1.1)

(We recommend that you use this one for more quicker and easier to update)

2. Update from rescue CF card (Please refer to section 8.1.2)

### 8.1.1. OS Updates from file

The OS update file can be obtained via the network. Before updating the OS, make sure the XP-8000-CE6 is connected to the network.

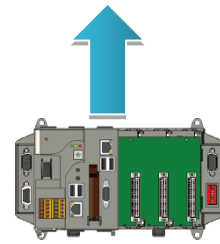

#### Step 1: Get the latest version of the OS image file, NK.bin

The latest version of the OS image file, NK.bin, can be found from ICP DAS web site.

<http://ftp.icpdas.com/pub/cd/xp-8x3x-ce6/rescue/ce6/>

#### Step 2: Replace an old one OS with a new one

The OS image, NB.bin are pre-installed on the \System\_Disk

#### Step 3: Reboot the XP-8000-CE6, the OS image has been updated completely

Run the XPAC Utility, click Reboot from the File menu for changes to take effect.

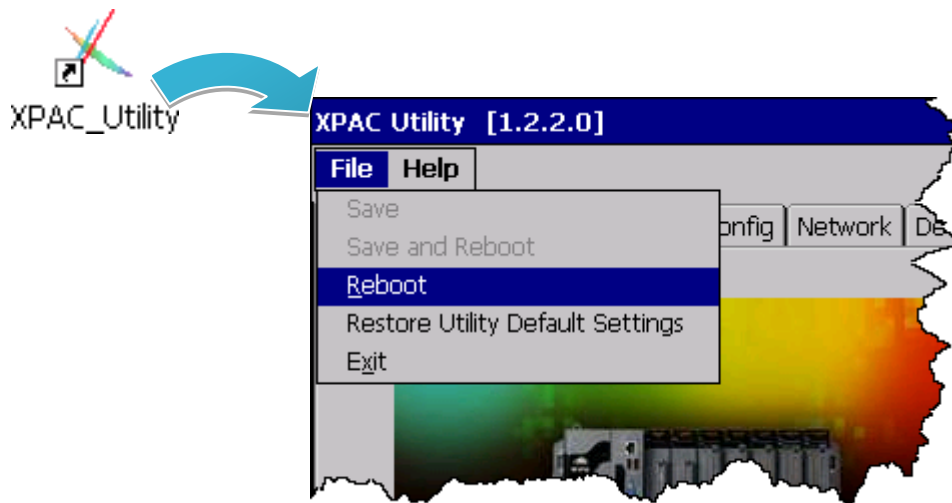

#### Step 4: Check the OS version

Run the XPAC Utility, and then select the Device Information tab to check the current OS version.

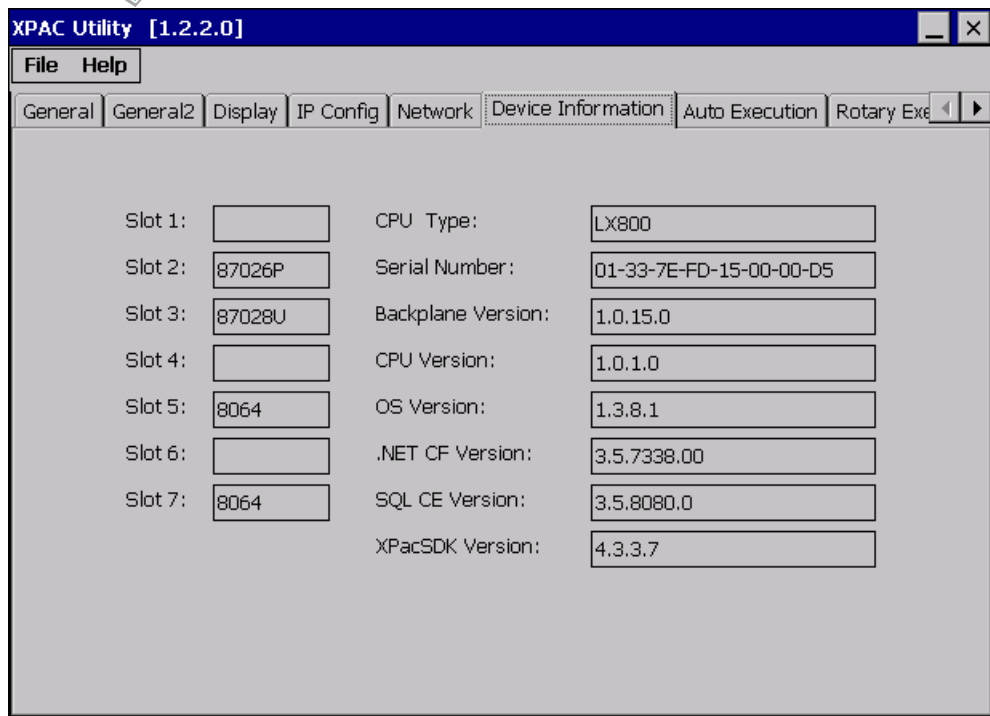

## 8.1.2. OS Updates using the Rescue CF Card

The XP-8000-CE6 can be reinstalled with the XP-8000-CE6 Rescue Utility. Before reinstalling the XP-8000-CE6, make sure the necessary updating files have been are available on your CF card.

For more information on how to reinstall the XP-8000-CE6, please refer to section 7.1. Recovering the XP-8000-CE6

## 8.2. SDK Updates

SDK update is a part of the XP-8000-CE6 update services to provide additional and more efficient features and functionality for XP-8000-CE6 operating system.

### 8.2.1. SDK Updates for VB.NET or C#

The SDK can be updated by replacing the PACNET.dll file.

#### Step 1: Get the latest version of the PACNET.dll file

The latest version of the PACNET.dll file can be obtained from ICP DAS web site.

<http://ftp.icpdas.com/pub/cd/xp-8x3x-ce6/sdk/xpacnet/pacnet/>

#### Step 2: Copy the latest version of PACNet.dll file to PC and XP-8000-CE6

The PACNET.dll file on PC can be placed anywhere only the solution can reference it.

The PACNET.dll file on XP-8000-CE6 is located at the same directory as the .exe file.

#### Step 3: Reboot the XP-8000-CE6, the SDK has been updated completely

Run the XPAC Utility, click Reboot from the File menu for changes to take effect.

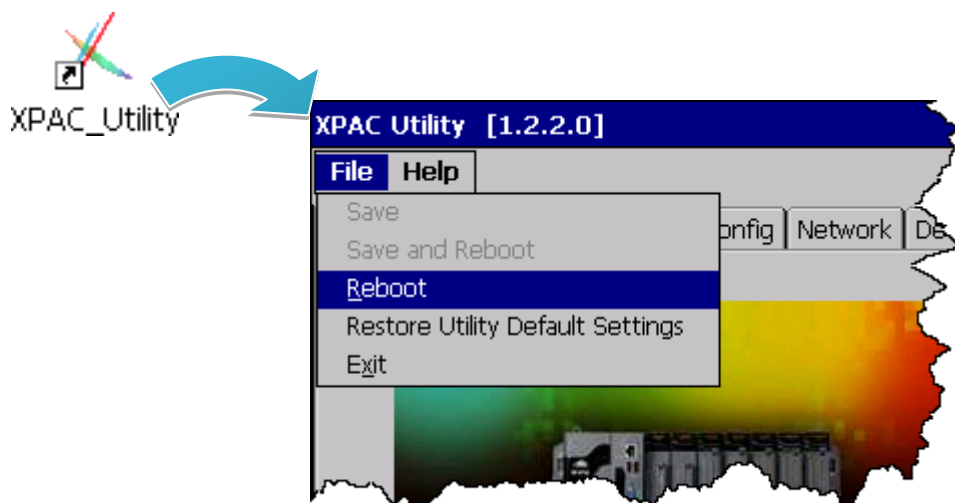

#### Step 4: Check the SDK version

Run the XPAC Utility, and then select the Device Information tab to check the current SDK version.

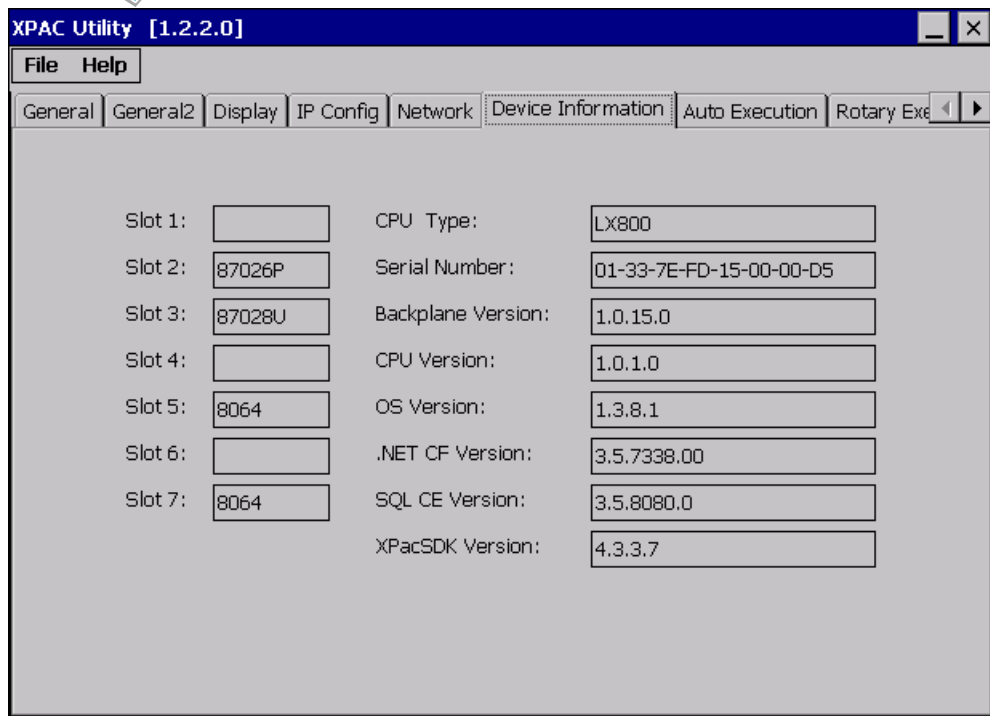

## 8.2.2. SDK Updates for VB.NET or Visual C++

The SDK can be updated by replacing the PAC SDK files.

### Step 1: Get the latest version of the VC++ components

The latest version of the VC++ components can be obtained from:

<http://ftp.icpdas.com/pub/cd/xp-8x3x-ce6/sdk/xpacsdk/pacsdk/>

### Step 2: Copy the latest version of header files and libraries to PC

The header files are located at:

C:\Program Files\Windows CE Tools\wce600\XPacSDK\_CE\Include\X86\

The libraries are located at:

C:\Program Files\Windows CE Tools\wce600\XPacSDK\_CE\Lib\X86\

### Step 3: Copy the latest version of DLL files to XP-8000-CE6

The DLL files are located at:

\System\_Disk\ICPDAS\System

### Step 4: Reboot the XP-8000-CE6, the SDK has been updated completely

Run the XPAC Utility, click Reboot from the File menu for changes to take effect.

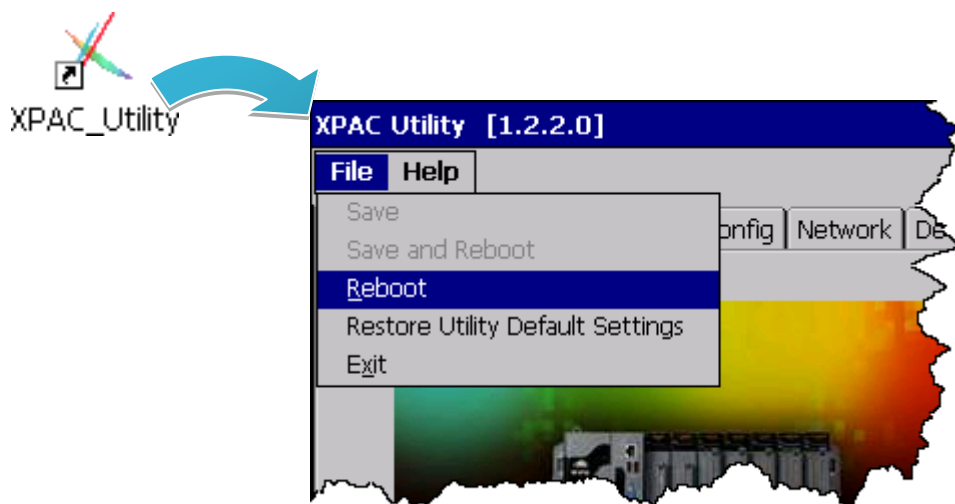

## Step 5: Check the SDK version

Run the XPAC Utility, and then select the Device Information tab to check the current SDK version.

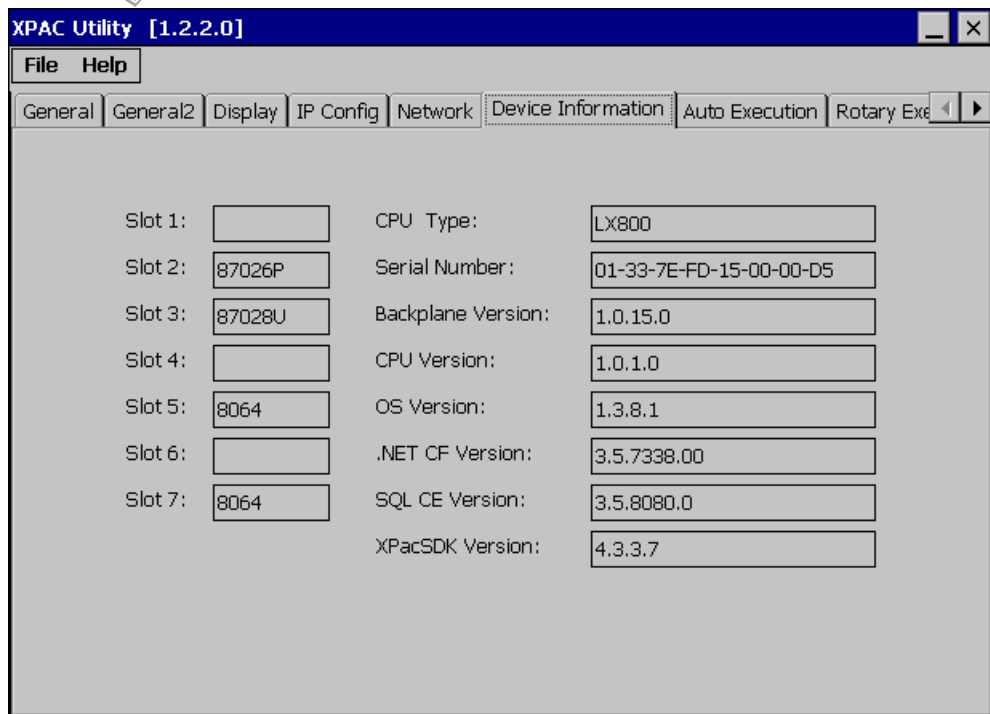



# 9. XP-8000-CE6 Download Center

This chapter provides a brief introduction of the XP-8000 -CE6 download center.

XP-8000 -CE6 has a download center where you can access the latest version of the software, tools, demo programs, and related information.

The XP-8000-CE6 Download Center can be found separately at:

<http://www.icpdas.com/root/support/download/download.php>

## *XP-8x31-CE6 Download Center*

**Note:**

When you download the software programs, you should notice if the programs conform to your machine. The published date and indicated requirement of a program can help user to determine the compatibility for your XP-8x31-CE6. Before you download any program, please read the notes of each online program first to avoid the confused situation.

The screenshot shows a web interface with navigation tabs: OS images, SDK, Utility & Tools, Demo, Documents, System Disk, and FAQ. The 'OS images download' section contains a note about compatibility, instructions on how to upgrade the OS image (copying a new NK.bin or reinstalling with a rescue utility), and a link to an 'Update OS manual' document titled 'How to update OS image' (v 1.0.2).

The categories of updates available from the XPAC Download Center include:

- **OS images:** This category contains the latest version of the XPAC OS.
- **SDK:** This category contains the latest version of the SDK for each XPAC component SDK, such as XPAC SDK, and Modbus SDK, etc.

- **Utility & Tools:** This category contains the latest version of the XPAC toolkits.
- **Demo:** This category contains all demo programs related to the XPAC.
- **Documents:** This category contains the latest versions of documents related to the XPAC.
- **System Disk:** This category contains the latest version of the XPAC toolkits.
- **FAQ:** This category contains answers to some common issues you may encounter while troubleshooting the XPAC.

## 10. Application of RS-485 Network

The RS-485 length can be up to 4000 ft or 1.2 km over a single set of twisted-pair cables, if the RS-485 network is over 4000 ft or 1.2Km, the RS-485 repeater must be added to extend the RS-485 network.

## 10.1. Basic RS-485 Network

The basic component of the RS-485 network consist of a Master Controller (or using a PC as a host controller), and some RS-485 devices.

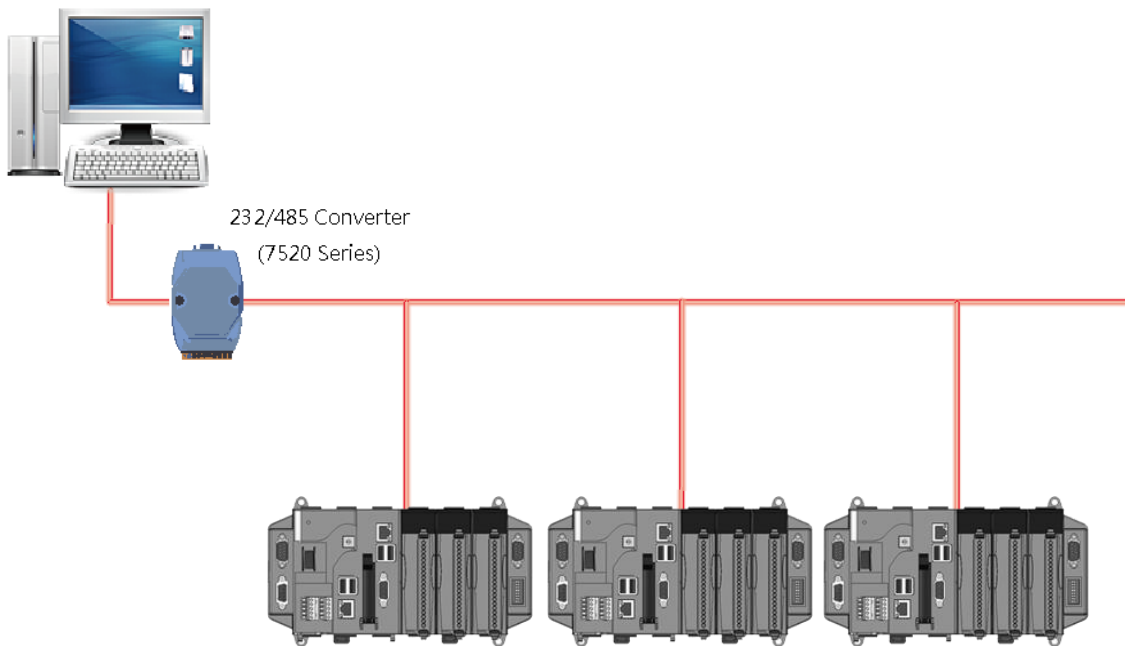

## 10.2. Daisy Chain RS-485 Network

All RS-485 devices are wired directly to the main network, If the network is up to 1.2 km, it will need a repeater (7510 series) to extend the network length.

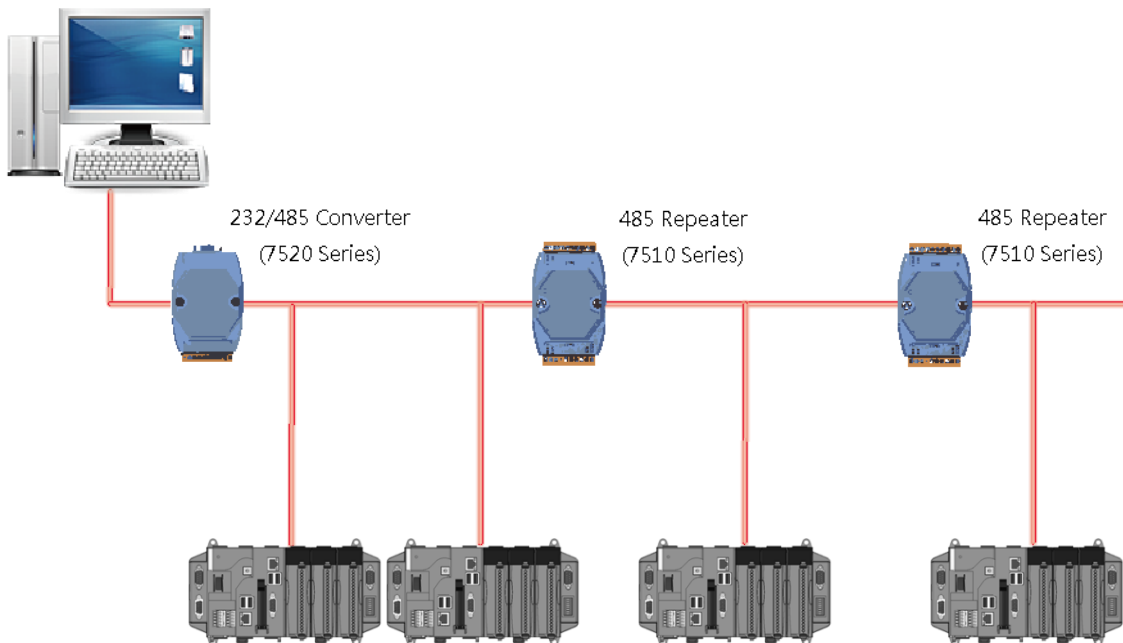

### 10.3. Star Type RS-485 Network

There are branches along the main network. In this case, it is better to have a repeater to isolate or filter the noise that is made by devices.

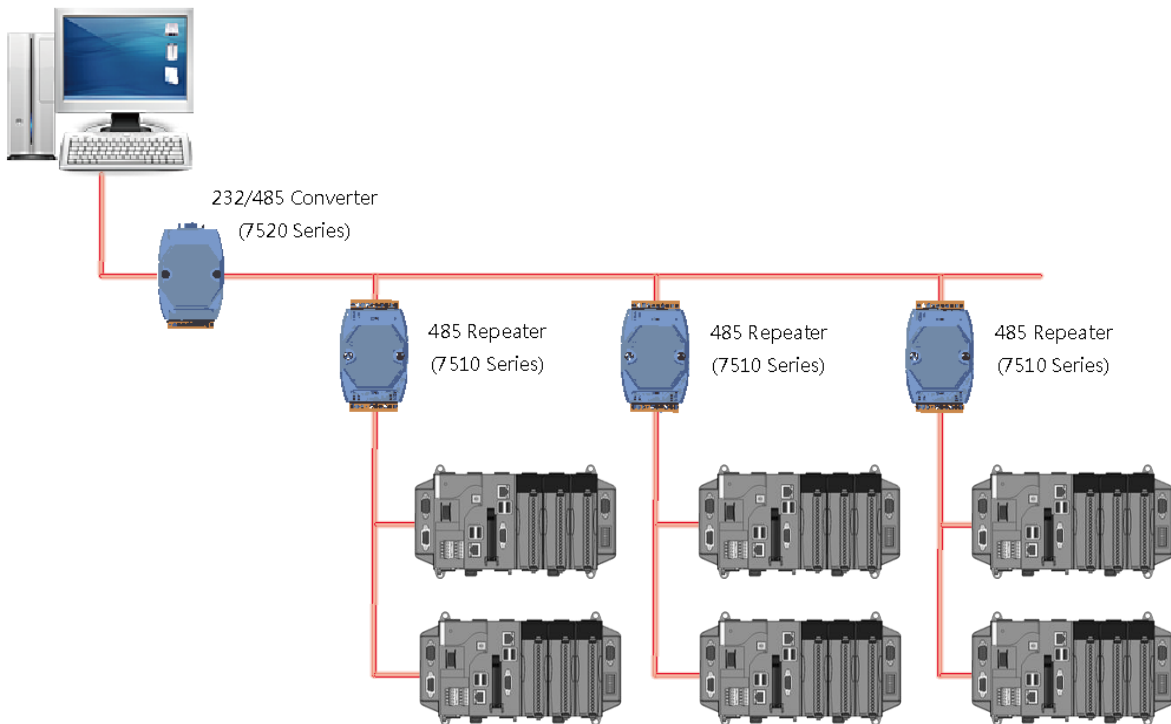

There is a better choice to use 7513 as a RS-485 hub on start type network.

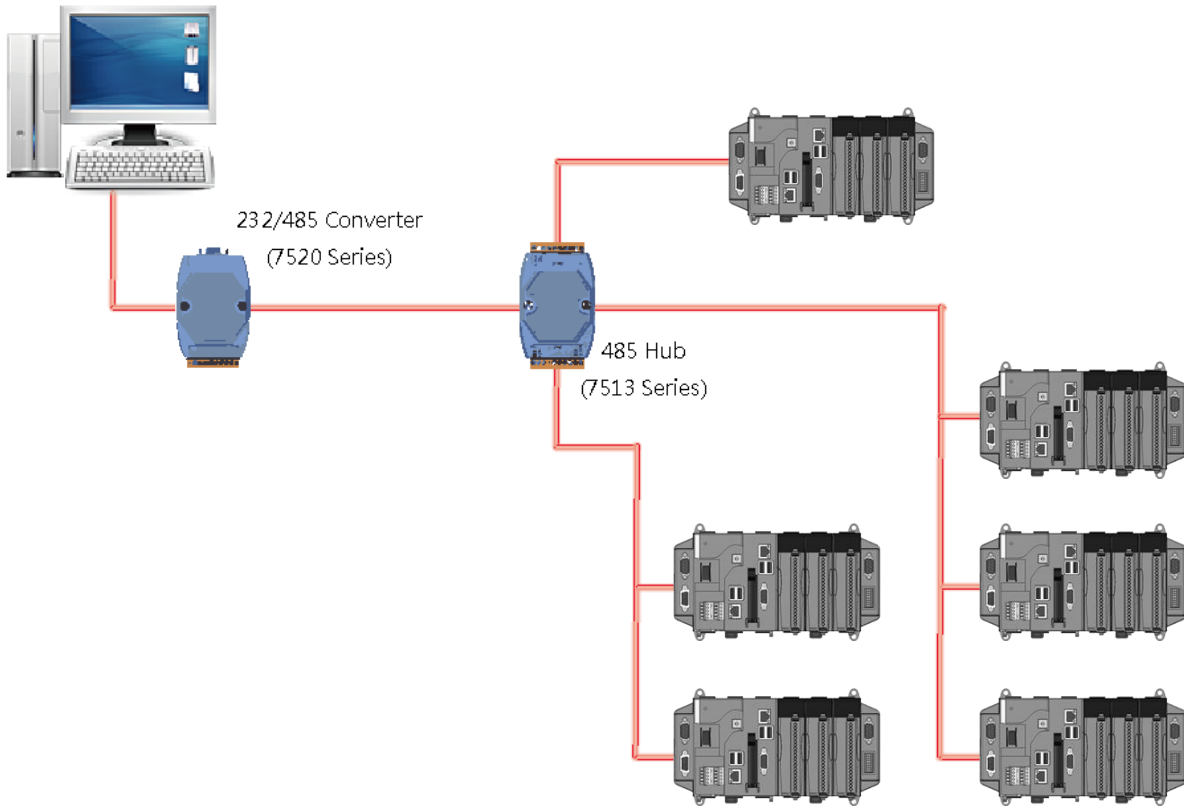

## 10.4. Random RS-485 Network

There are branches along the main wire. In this case, it is better to have a repeater to isolate or filter the noise that is made by devices.

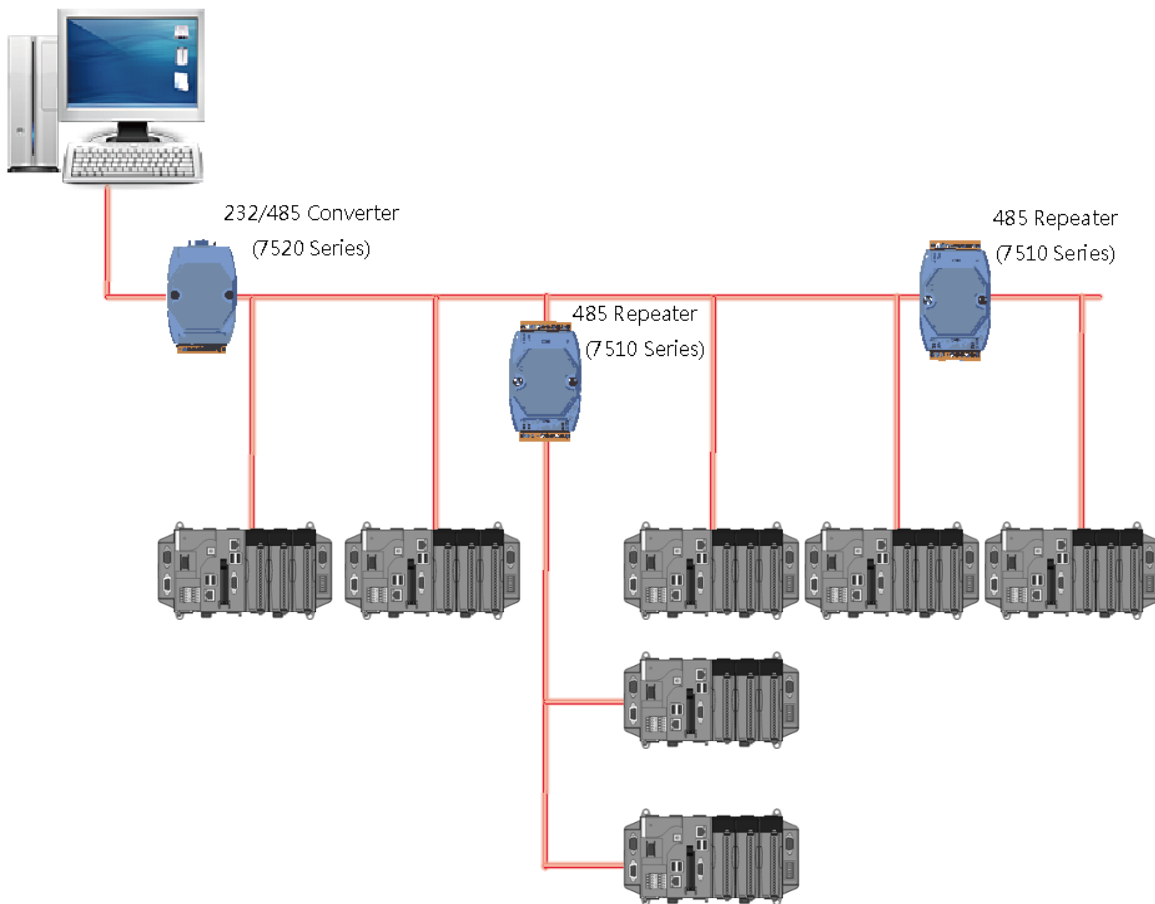



## 10.5. Master/Slave Settings

The RS-485 network based on master-slave architecture consists of a single master device and one or more slave devices.

The XPAC provides two RS-485 communication interfaces based on the master-slave system architecture, all of which have a pull-high/pull-low resistor, user can set it to master or slave for implementing an RS-485 multi-drop network.

One of the RS-485 communications, COM3, its pull-high/pull-low resistor located on power board, the other, COM4, located on the right side and its pull-high/pull-low resistor located on the bottom of the right side, as shown below.

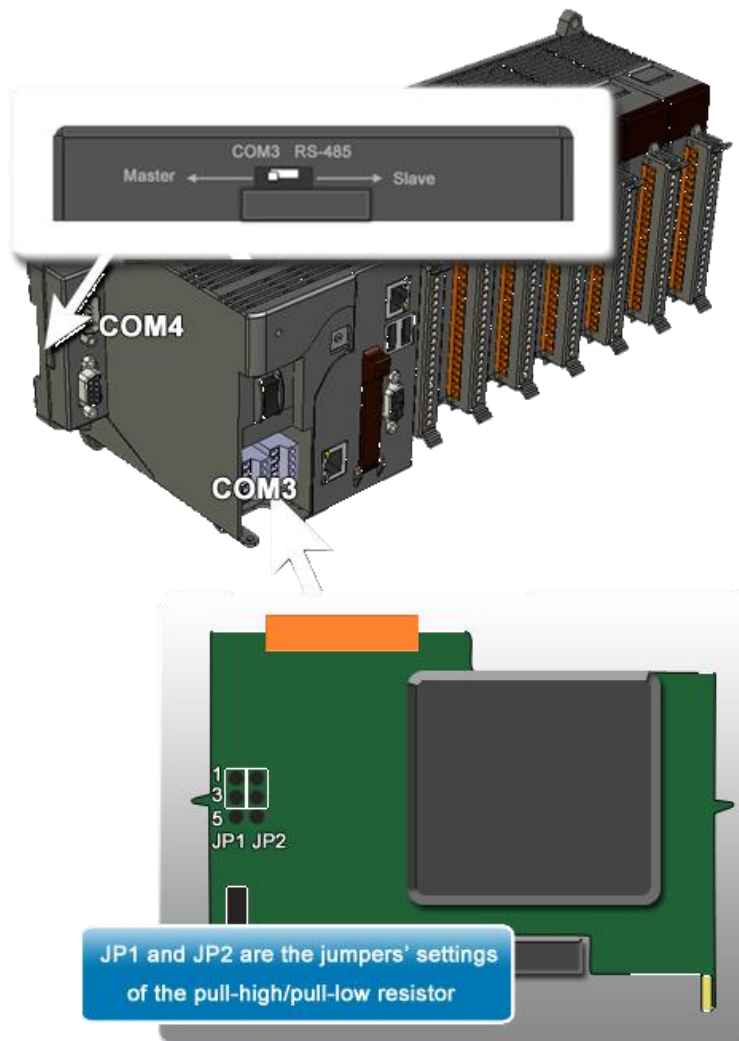

### 10.5.1. XPAC as a Master (Default)

When one of XPAC is set to master, then all the other devices on the same network must be slave mode. If the network is up to 1.2 KM, it will need a repeater (7510 series) to extend the network length.

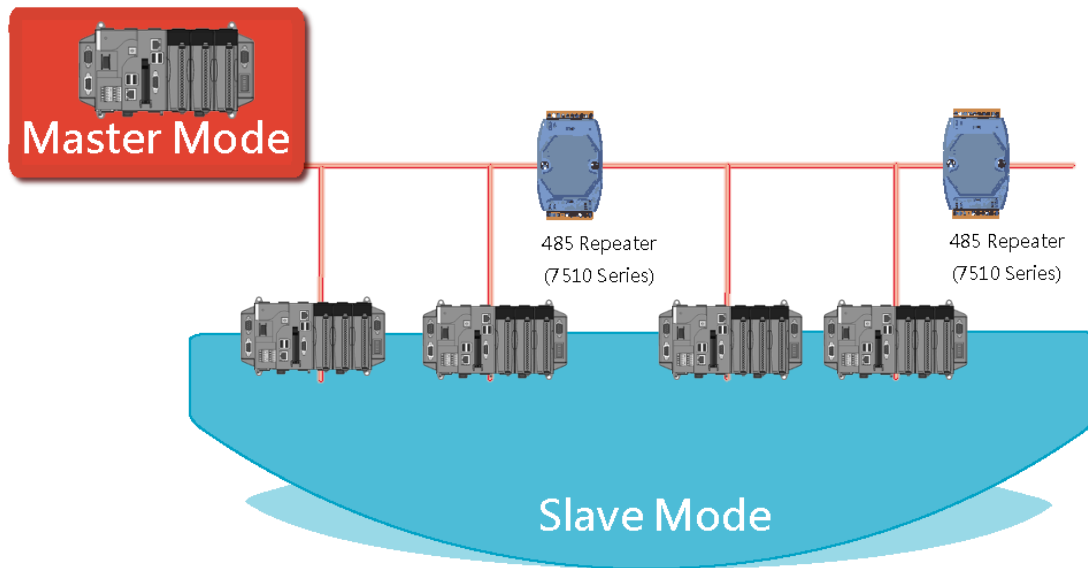

When XPAC as a master using COM3 communication interface, the pull-high/pull-low resistor located on the power board must adjust to enable as showed below.

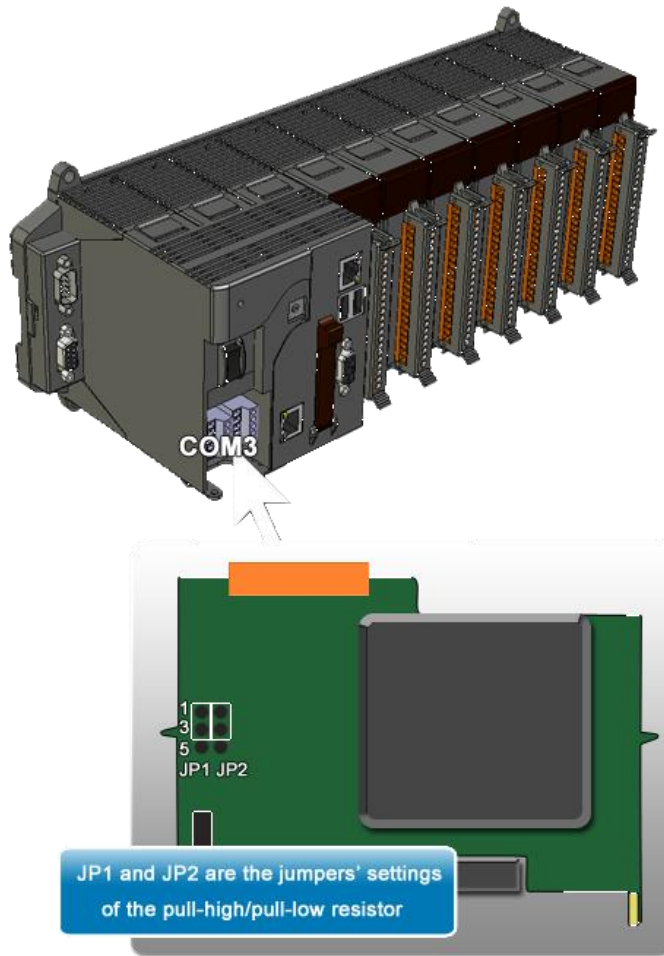

When XPAC as a master using COM4 communication interface, the pull-high/pull-low resistor located on the power board must adjust to enable as showed below.

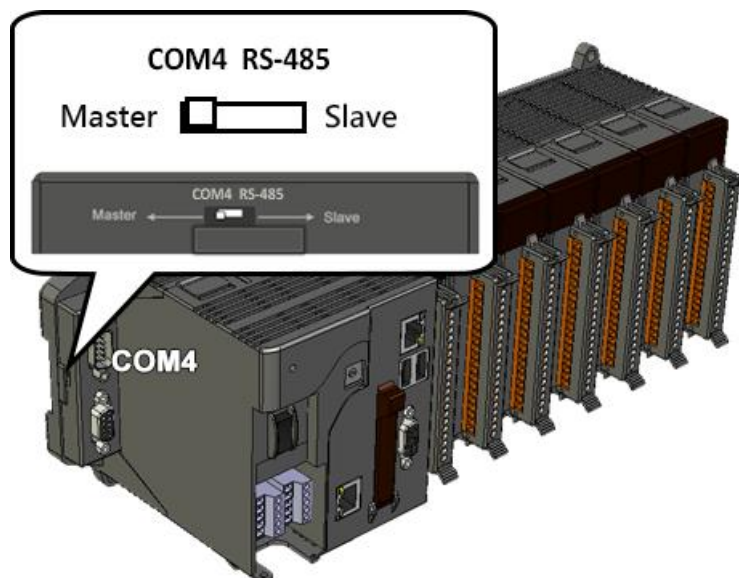

## 10.5.2. XPAC as a Slave

For most of application, when using one 7520 series as RS-232/485 converter, its pull-high/pull-low resistors are set to enabled. Then the XP-8000-CE6 and all the other devices on this network must be slave mode (the pull-high/pull-low resistors must be disabled).

If there are repeaters on the RS-485 network, there will be pull-high/pull-low resistors on both sides of the repeaters (I-7510)

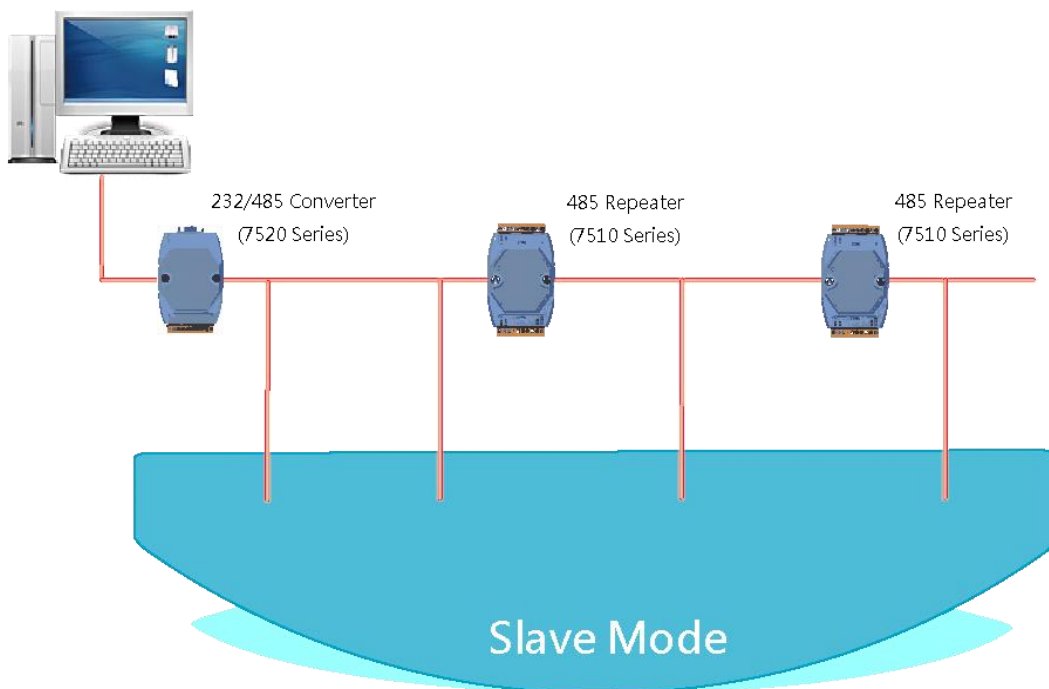

When XPAC as a slave using COM3 communication interface, the pull-high/pull-low resistor located on the power board must adjust to enable as showed below.

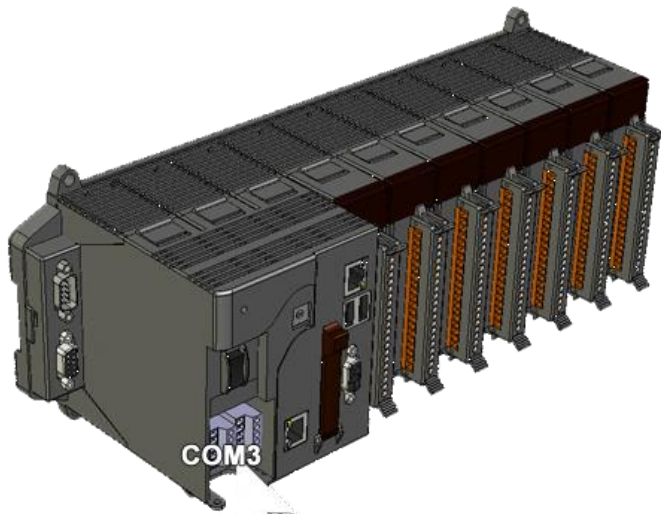

When XPAC as a slave using COM4 communication interface, the pull-high/pull-low resistor located on the bottom of the right side, as showed below.

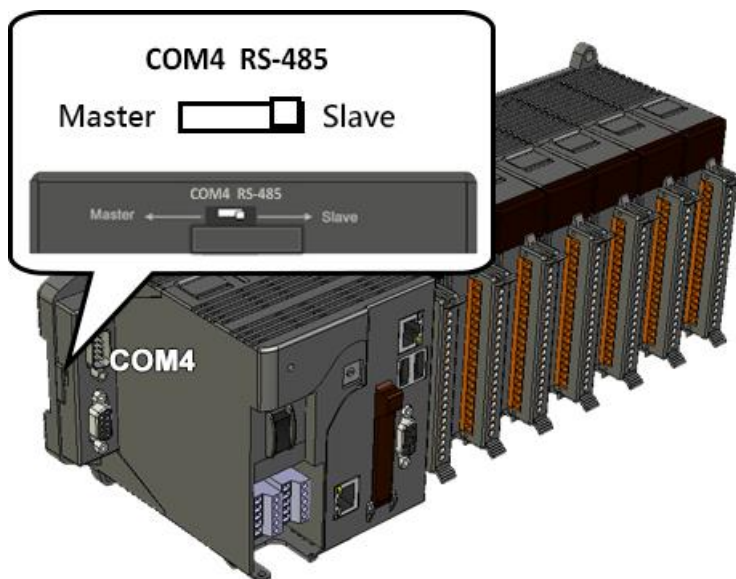

## Tips – How to

This chapter provides tips and a guided tour on using and maintaining the XP-8000.

## A. How to Use the Printer

XP-8000-CE6 have ability to access the printer, the printer can be connected via an Ethernet or a USB.

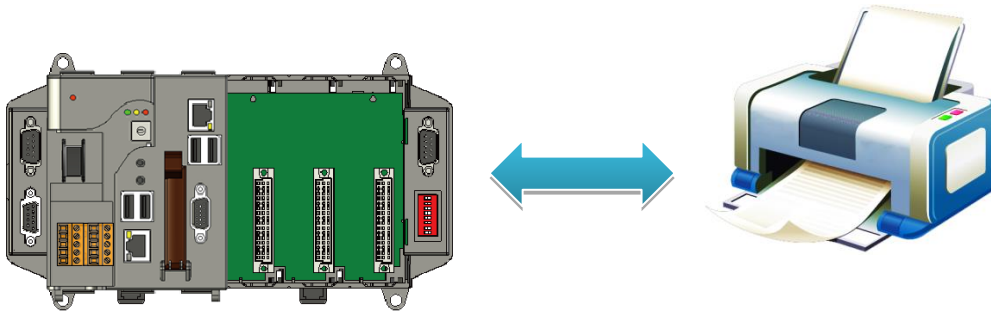

### Tips & Warnings

---



XP-8000-CE6 only supports HP Laser Jet Printers with PCL6 driver. The following printer support is released by HP:

- HP LaserJet 4000 series/HP LaserJet 4100 series
- HP LaserJet 2100 series/HP LaserJet 2200 series
- HP LaserJet 1200
- HP LaserJet 3200/HP LaserJet 3300
- HP LaserJet 4200 series/HP LaserJet 4300 series
- HP LaserJet 5000 series/HP LaserJet 5100 series
- HP LaserJet 8000 series
- HP LaserJet 9000 series printers

If you need the latest support of HP PCL6 printer, you can refer to following link

<http://h20000.www2.hp.com/bizsupport/TechSupport/Document.jsp?objectID=bpl04568>

---

## A.1. How to Use a Network Printer

Here are step by step instructions on how to use a shared printer.

### Step 1: On PC side, check the name of the PC and the shared printer

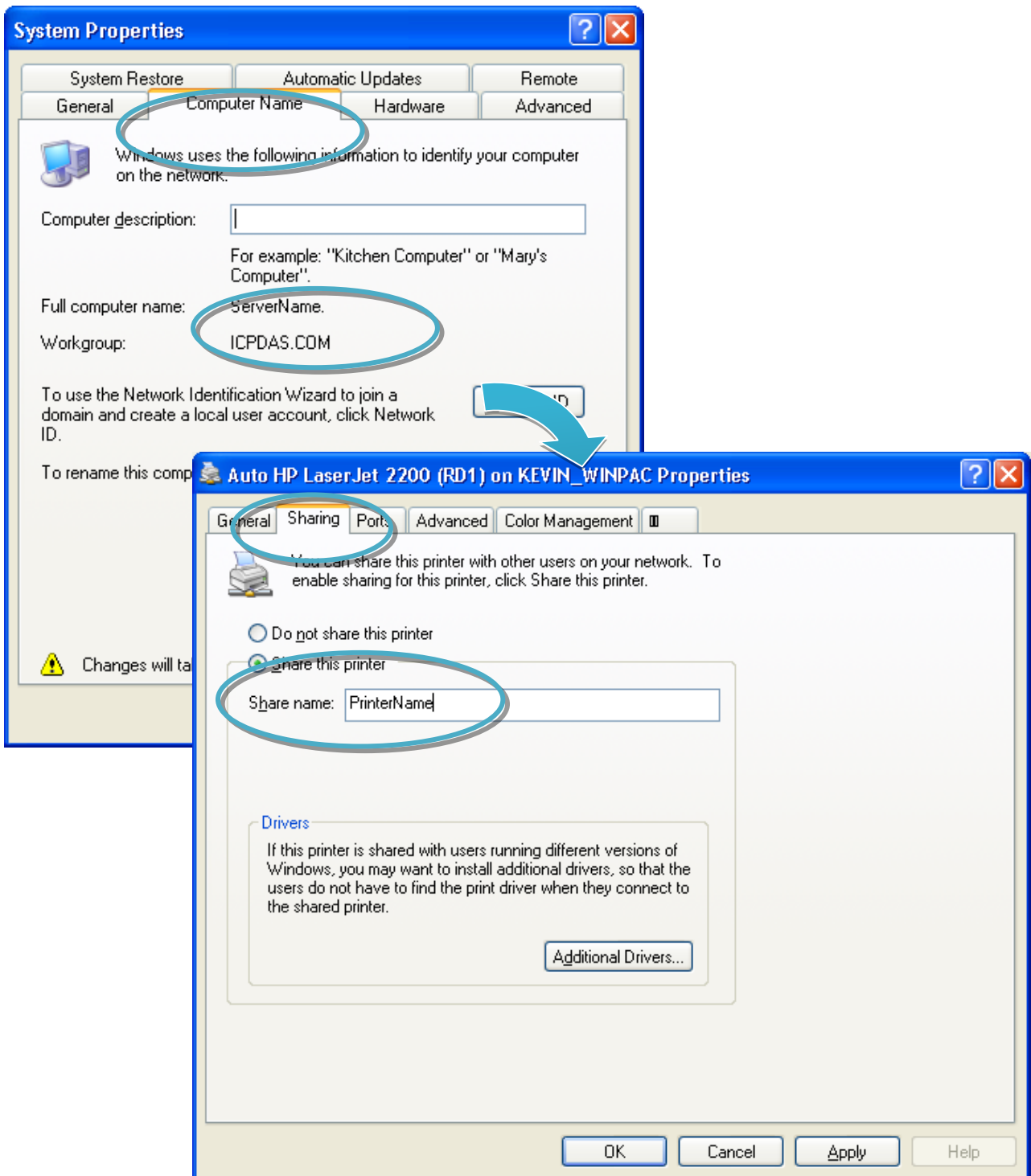



**Step 2: On XP-8000-CE6 side, run the Notepad, and then open a WordPad format file**

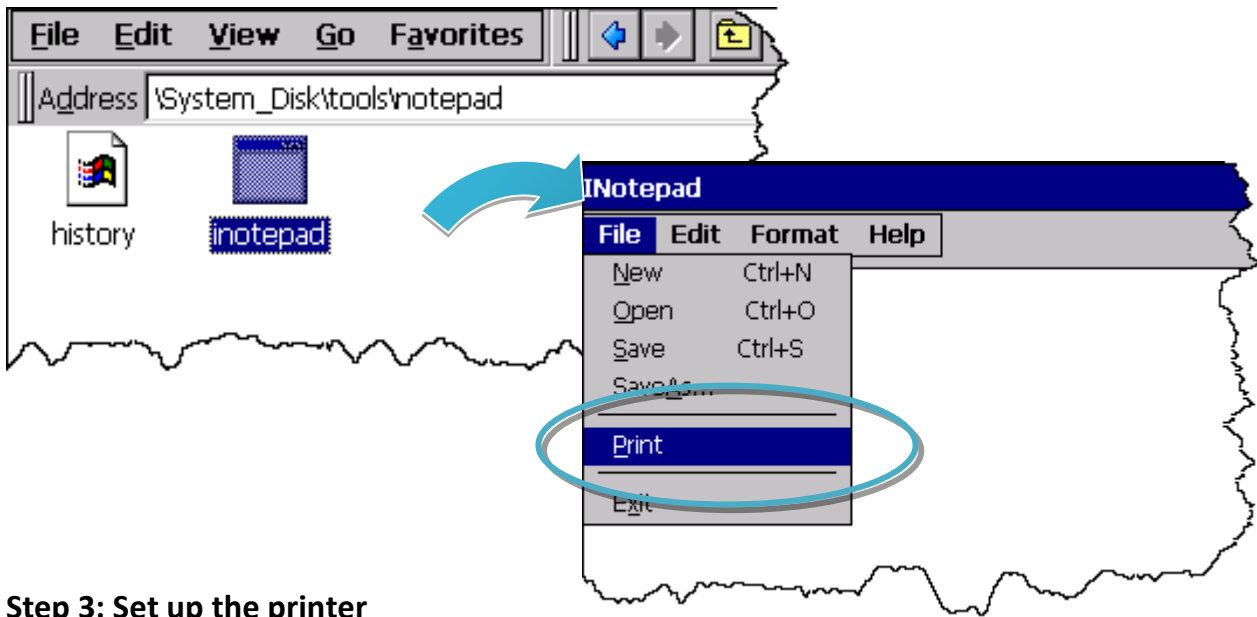

**Step 3: Set up the printer**

- 1. Printer: PCL Laser
- 2. Port: Network
- 3. Net Path: \\ServerName\PrinterName

The "ServerName" is the name or IP of the PC.

The "PrinterName" is the name of share printer of the PC.

- 4. Paper Size: Select the paper size



**Test !!!**

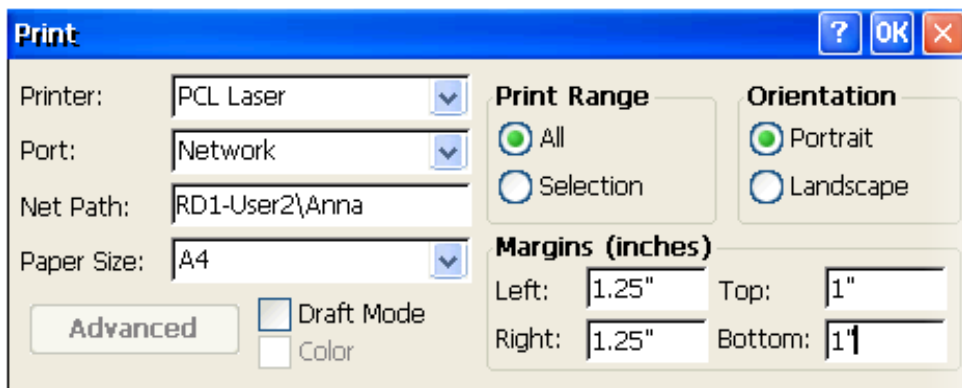

## A.2. How to Use a USB printer

Here are step by step instructions on how to use a USB printer via a USB port.

### Step 1: Run the Notepad, and then open a WordPad format file

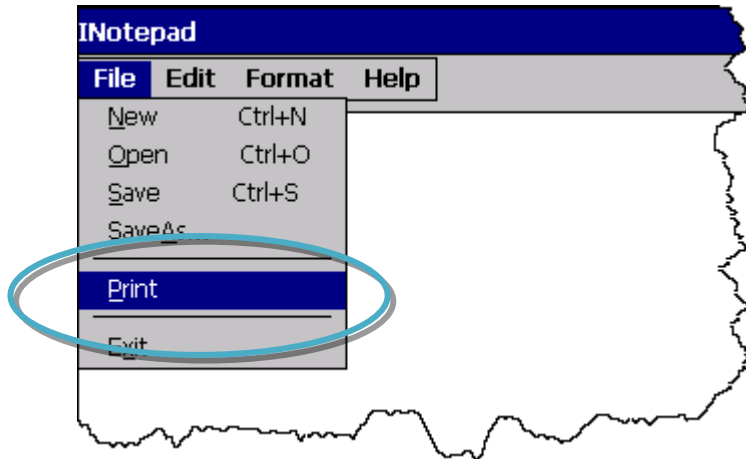

### Step 2: Set up the printer

1. Printer: Hewlett-Packard LaserJet
2. Port: LPT1
3. Paper Size: Select the paper size



**Test !!!**

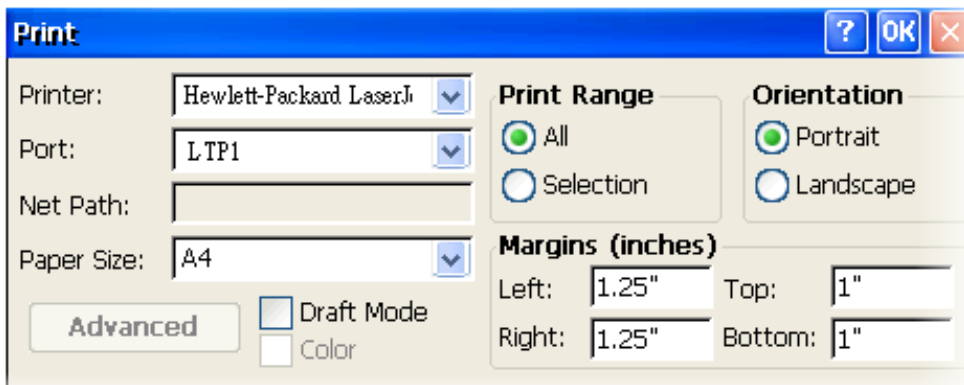

## B. How to Online Debug the XP-8000-CE6 Program

Here are step by step instructions on how to online debug the XP-8000-CE6 program.

### Tips & Warnings

---



Before starting online debug the XP-8000-CE6 program, make sure that the XP-8000-CE6 SDK has been installed correctly.

For more information on how to install the XP-8000-CE6 SDK, please refer to 4.1.2. Installing the XP-8000-CE6 SDK.

---

### Step 1: Copy the following files to the \System\_Disk\icpdas\system on the XP-8000

By default, these files are located on the development computer at C:\Program Files\Common Files\Microsoft Shared\CoreCon\1.0\Target\wce400\<CPU>.

- clientshutdown.exe
- CMAccept.exe
- ConmanClient2.exe
- eDbgTL.dll
- TcpConnectionA.dll

### Step 2: Run the ConmanClient2.exe and then CMAccept.exe on the XP-8000-CE6

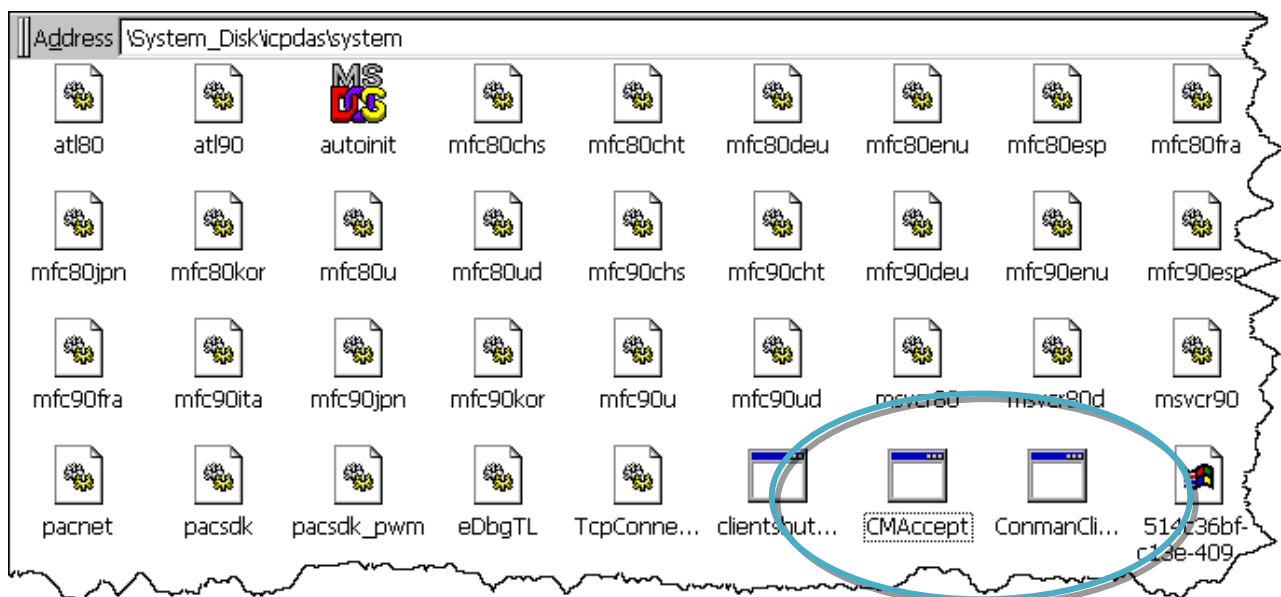

**Step 3: On the Tools menu, click the Options**

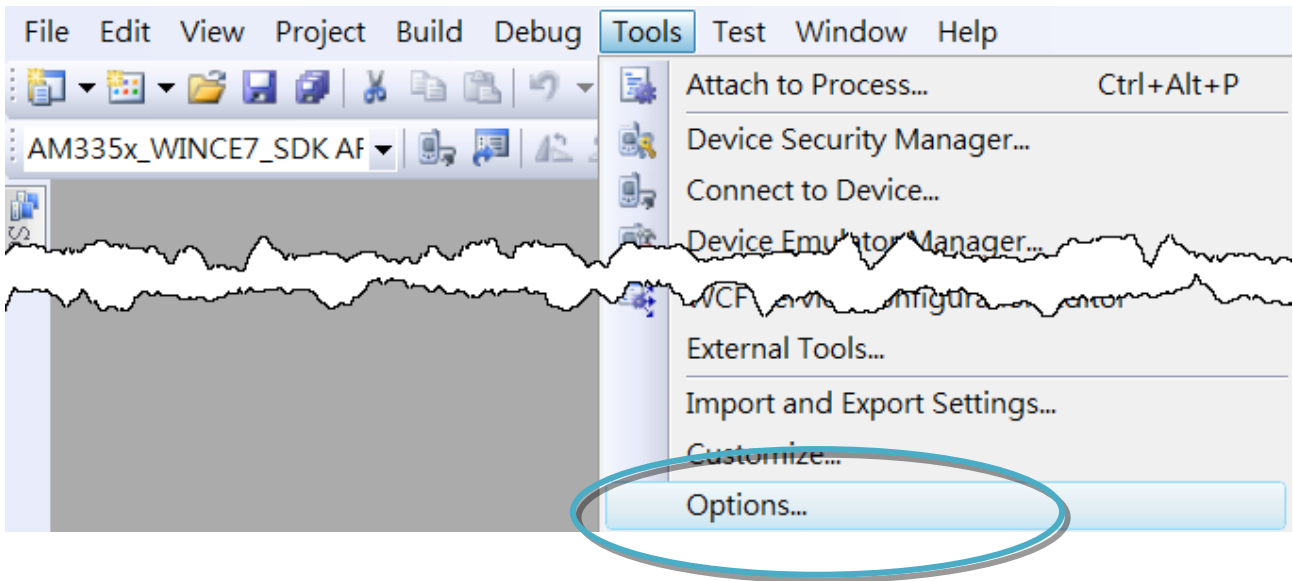

**Step 4: In the left pane, expand Device Tools node and select Devices**

**Step 5: In the Show devices for platform:, select XPacSDK\_CE and then click Properties**

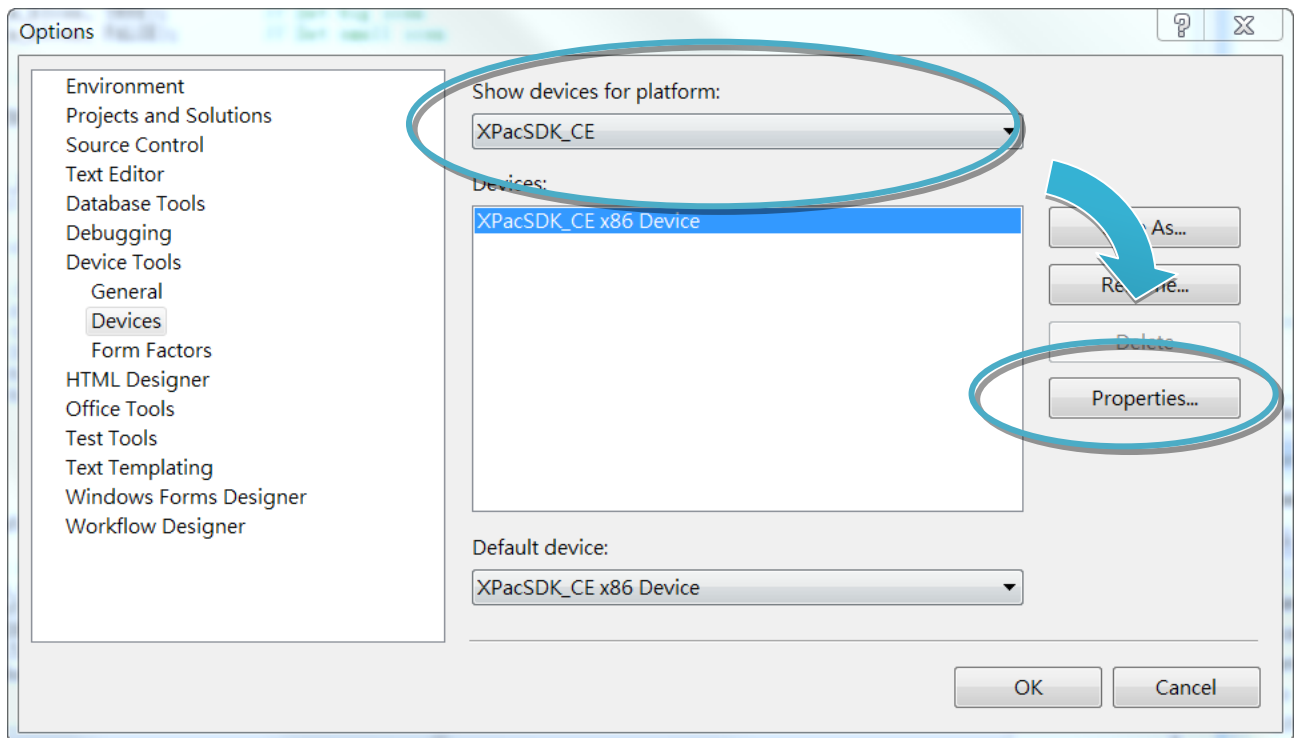

**Step 6: Click the Configure...**

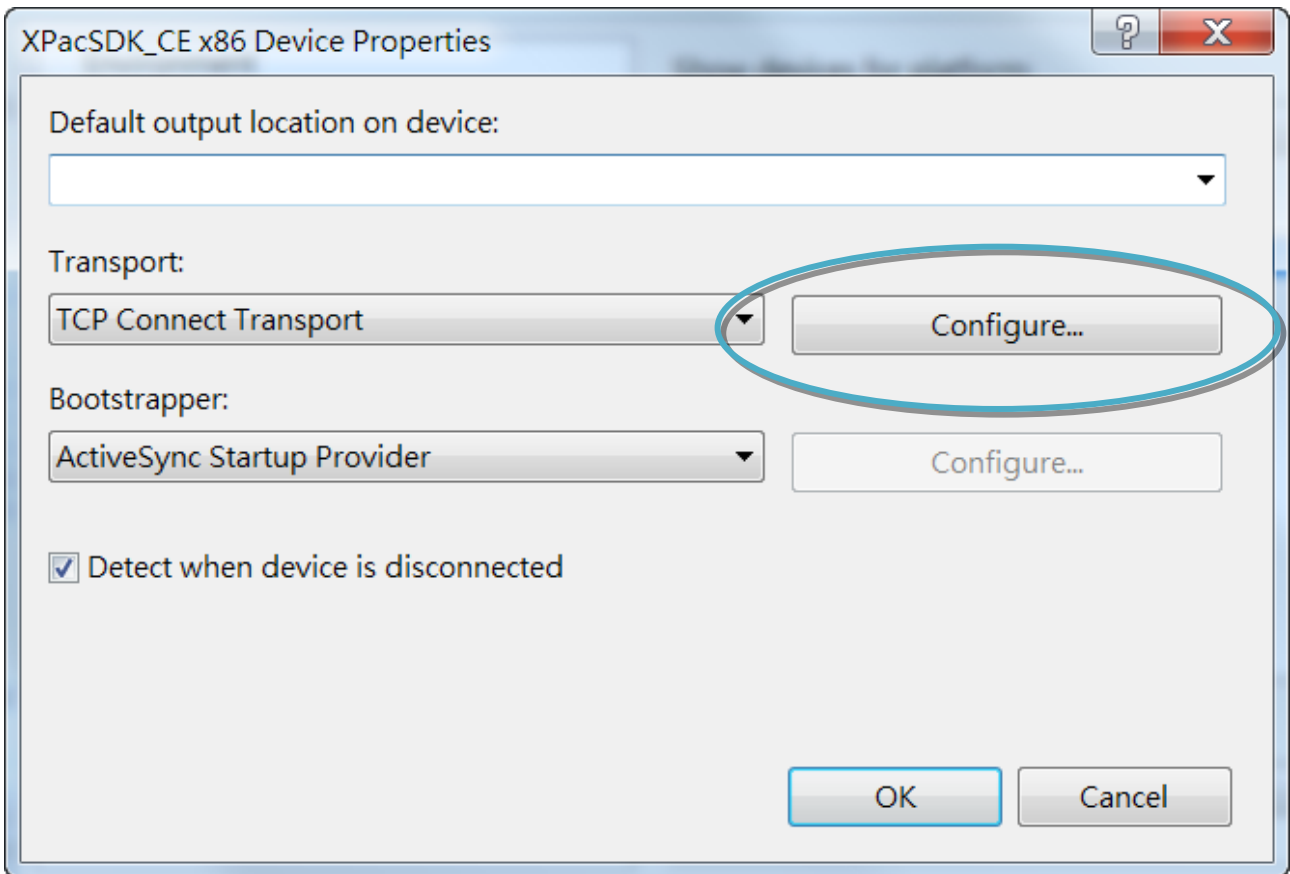

**Step 7: Select the Use specific IP address:, and then type the IP address of XP-8000-CE6**

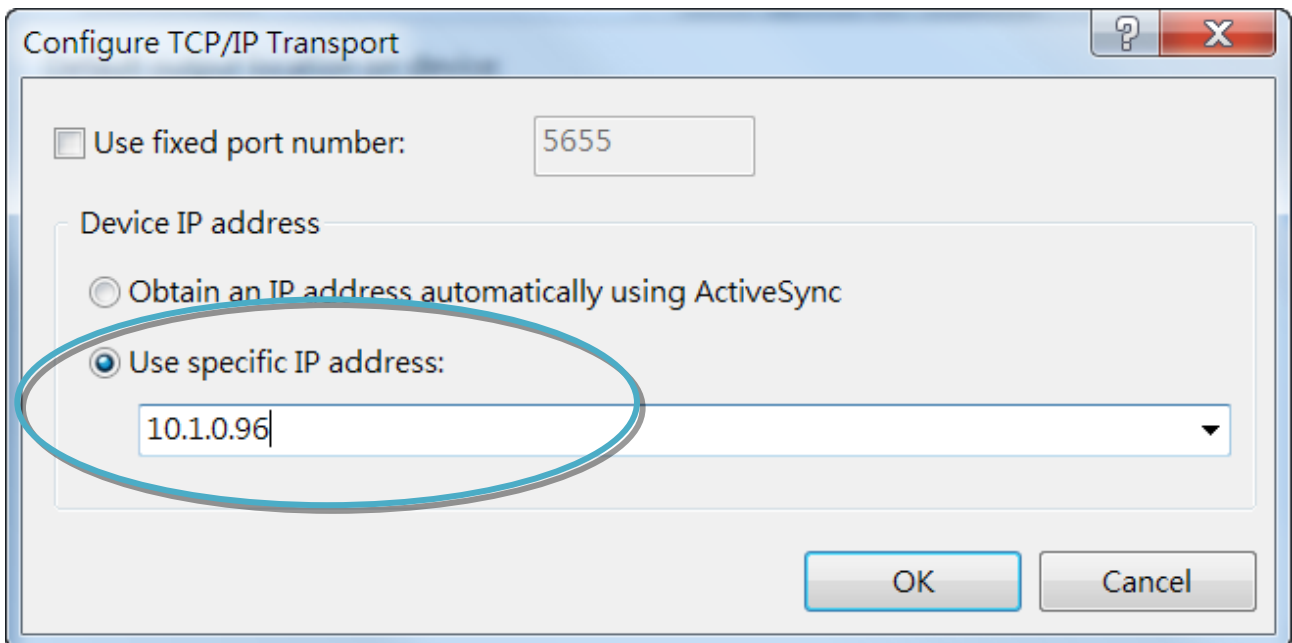

**Step 8: Click the OK, and then click OK to end the dialog**

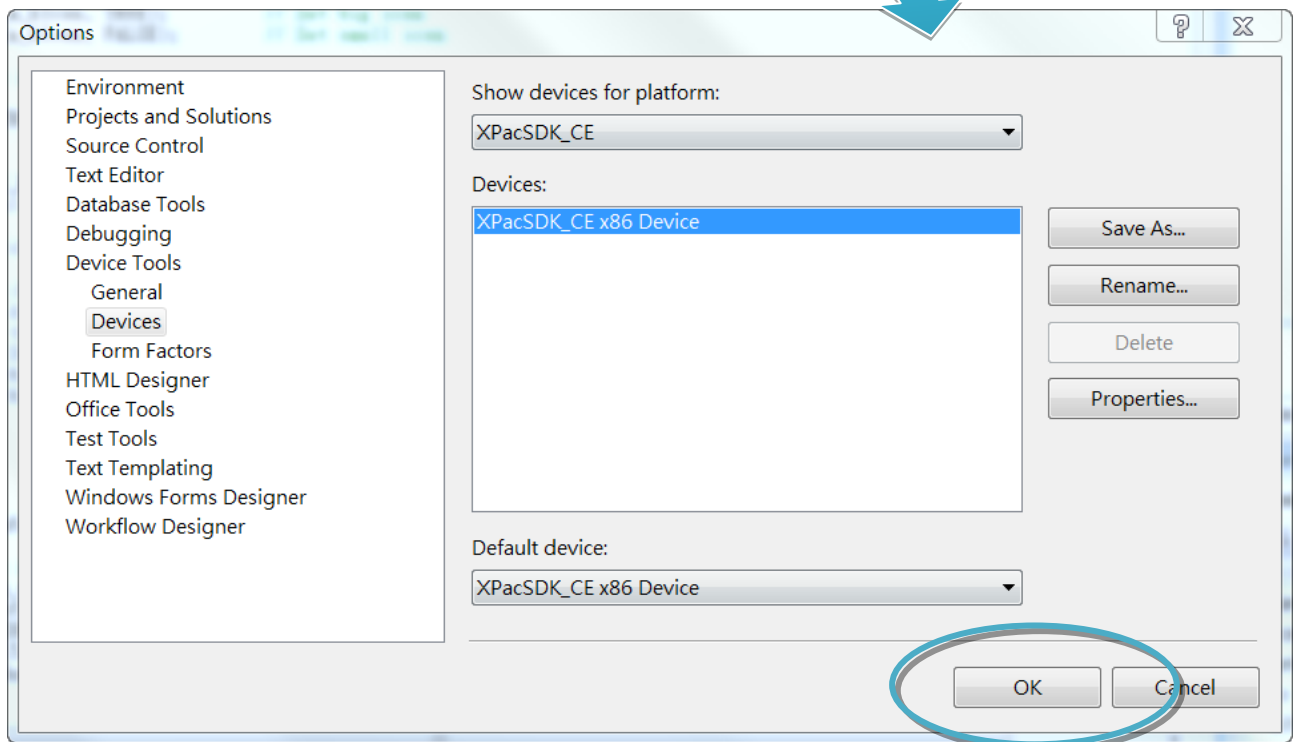
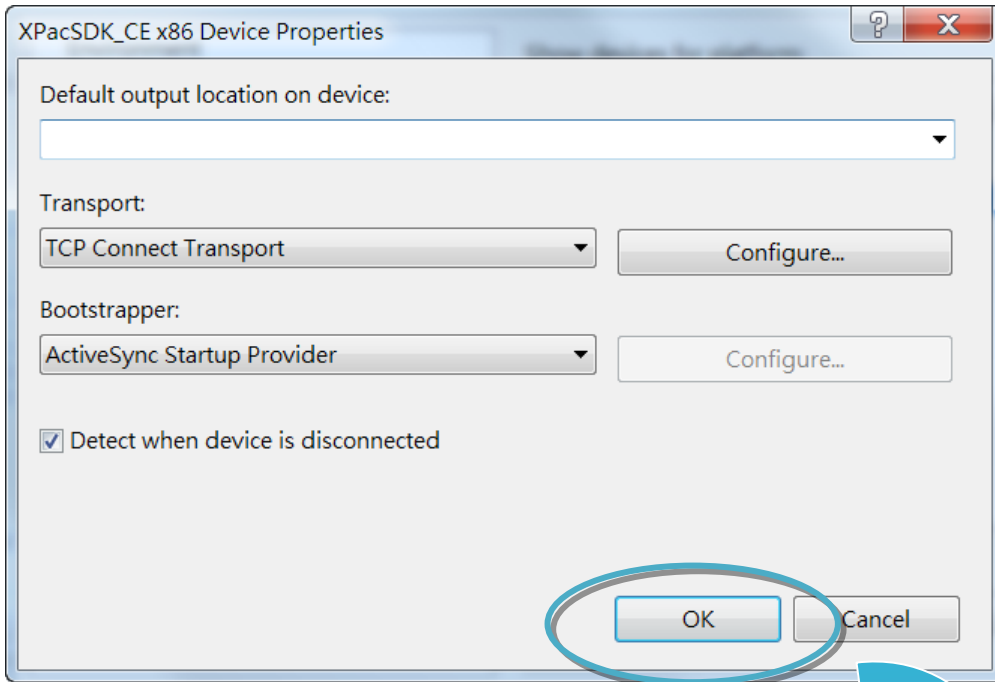

**Step 9: On the Tools menu, click the Connect to Device...**

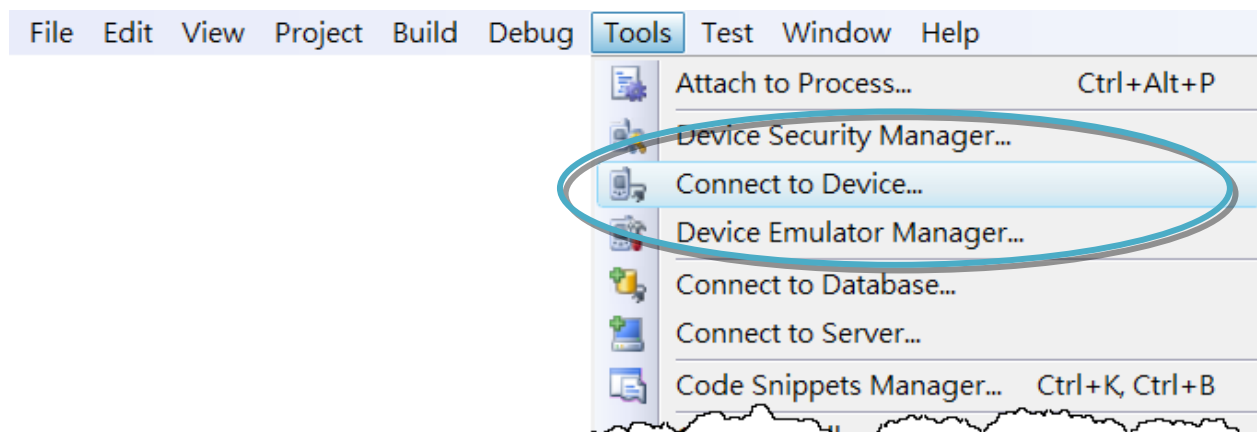

**Step 10: Click the Connect**

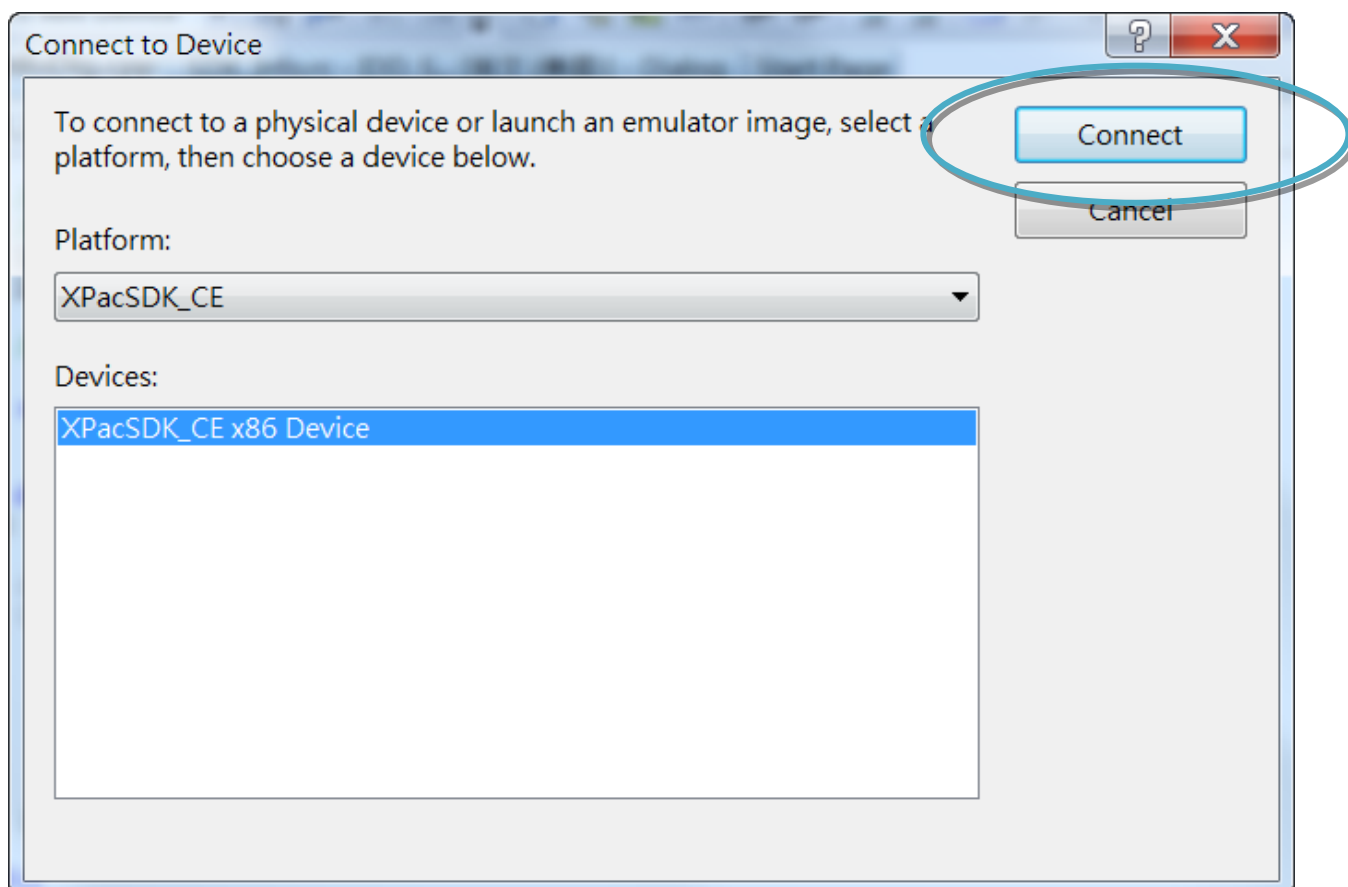

## Step 11: Wait for the connection to be established

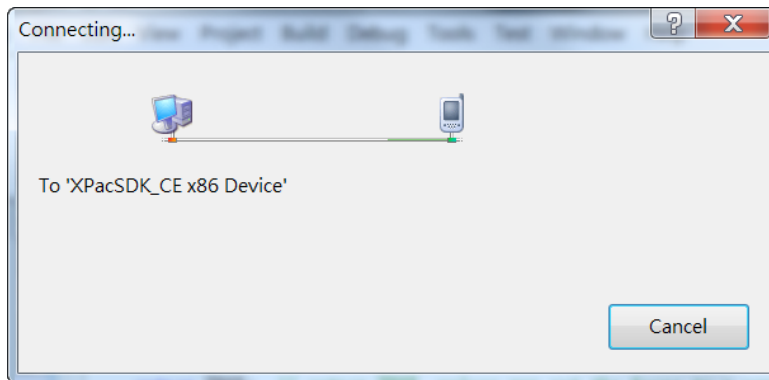

### Tips & Warnings



If the connection fails shown as follow, return to step 10 to do the action



Open the command prompt, run the “ConmanClient2.exe/transport:tcpconnectiona.dll/property:port=5000/id:Con on” at: \System\_Disk\ICPDAS\System, and then run the “CMAccept.exe”

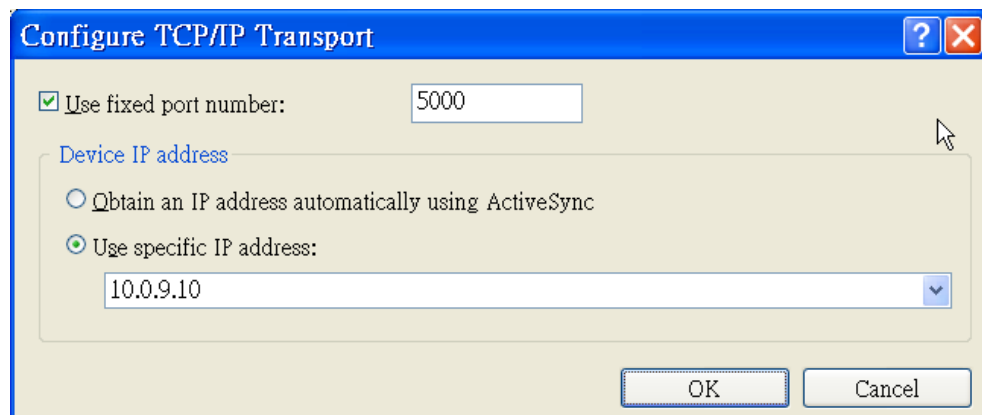
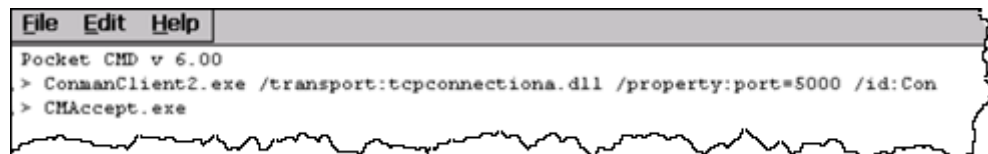



## C. How to Automatically Synchronize XP-8000-CE6 Clock with an Internet Time Server

The clock on the XP-8000-CE6 can be synchronized with an internet time server. This means that the clock is updated to match the clock on the time server, which can help ensure that the time on the XP-8000-CE6 is accurate. Here are step by step instructions on how to synchronize the clock on the XP-8000-CE6 with an Internet time server.

### Step 1: Run the XPAC Utility



### Step 2: On the General tab, press Configure button

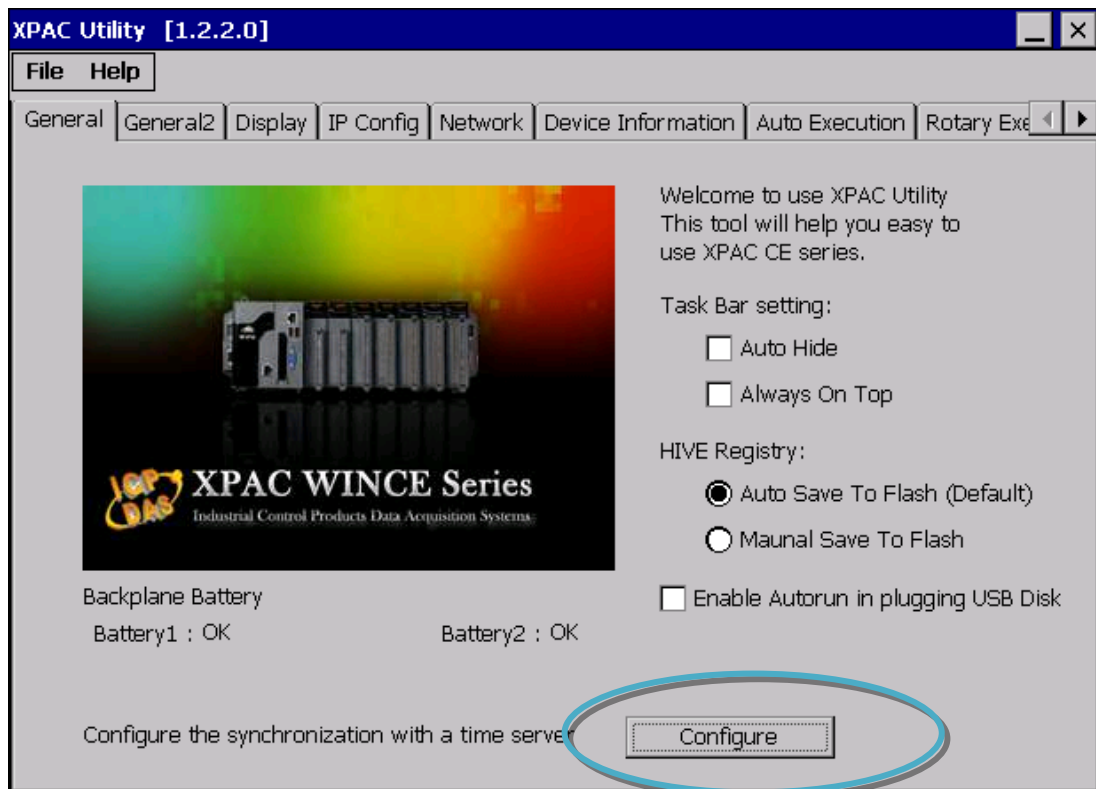

**Step 3: Select the domain name from the Server drop-down list, and then enter a value in the Autoupdate Frequency field**

**Step 4: Check the Automatically synchronize with an internet time server check box**

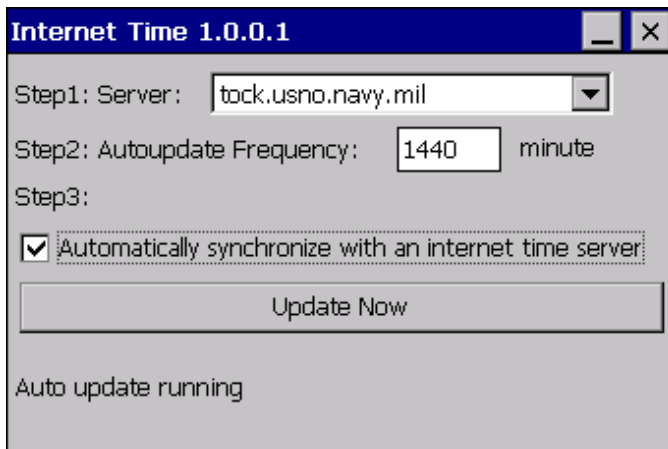

**Step 5: On the File menu, click Reboot**

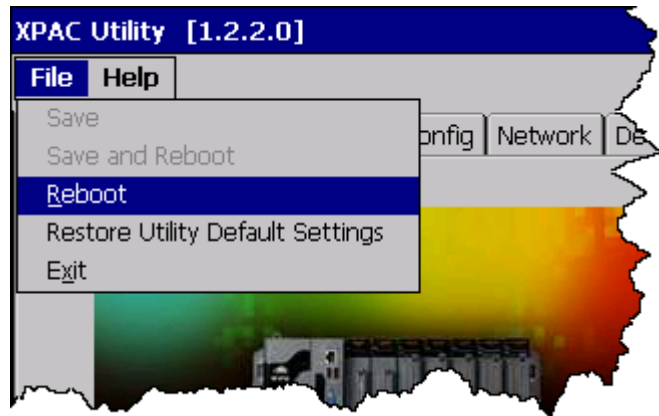

**Step 6: The XP-8000-CE6 will automatically synchronize with an internet time server regularly**

**Step 7: Click the Update Now button to synchronize XP-8000-CE6 clock immediately**

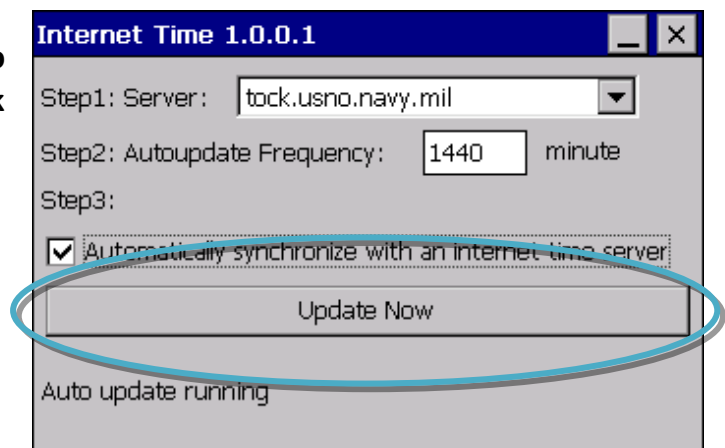

## D. How to Control the User Account Control in XP-8000-CE6

User Account Control is a security feature that helps prevent unauthorized system changes to the XP-8000-CE6.

## D.1.How to Create a User Account

Here are step by step instructions on how to add a user account.

### Step 1: Run the XPAC Utility



### Step 2: On the Login tab of the Network tab, click Login tab, type the User Name and Password, and then click Add button

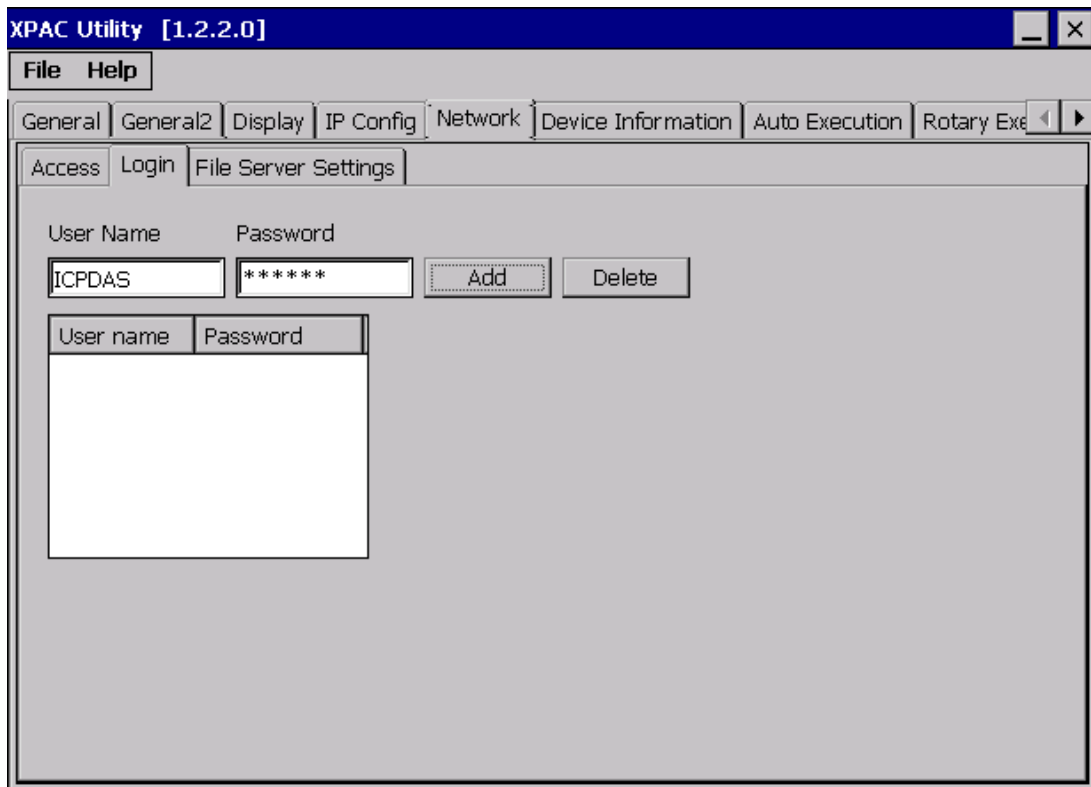

**Step 3: The user has been added to the allowed under the remote login and included in the following list**

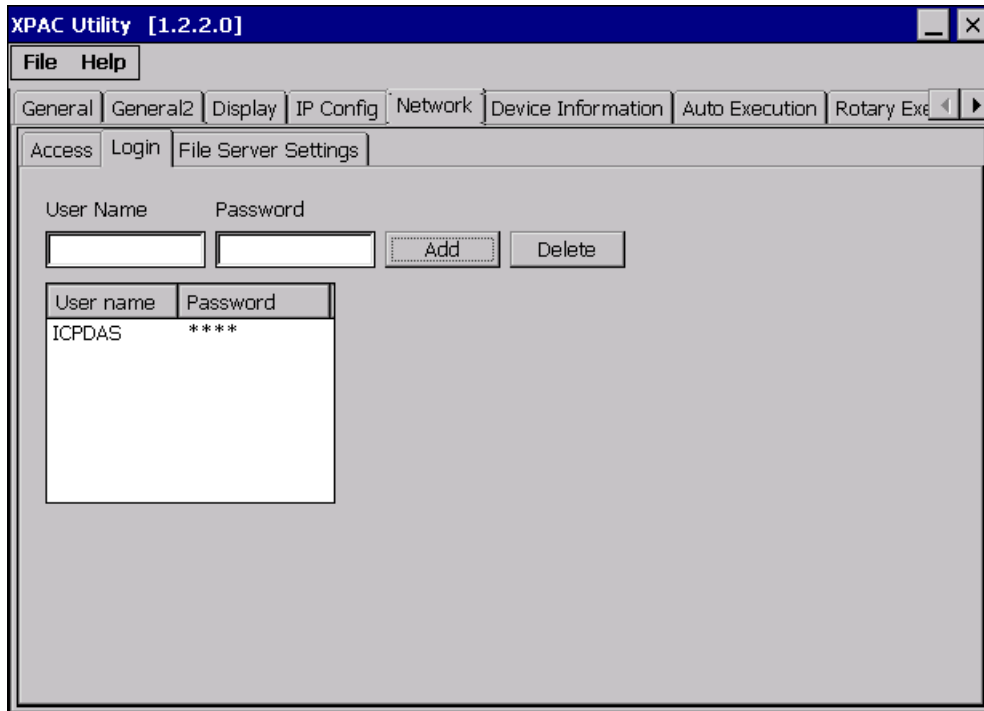

**Step 4: On the File menu, click Reboot for changes to take effect**

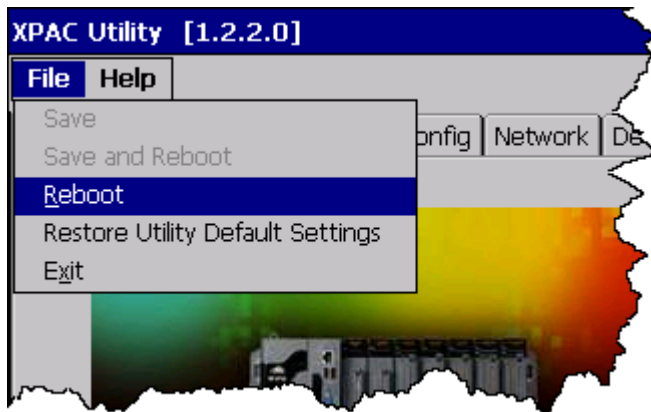

## D.2.How to Telnet to Remote Login the XP-8000-CE6 from PC

Here are step by step instructions on how to use telnet to remote login the XP-8000-CE6 from PC.

### Step 1: On the PC, open a MS-DOS command prompt

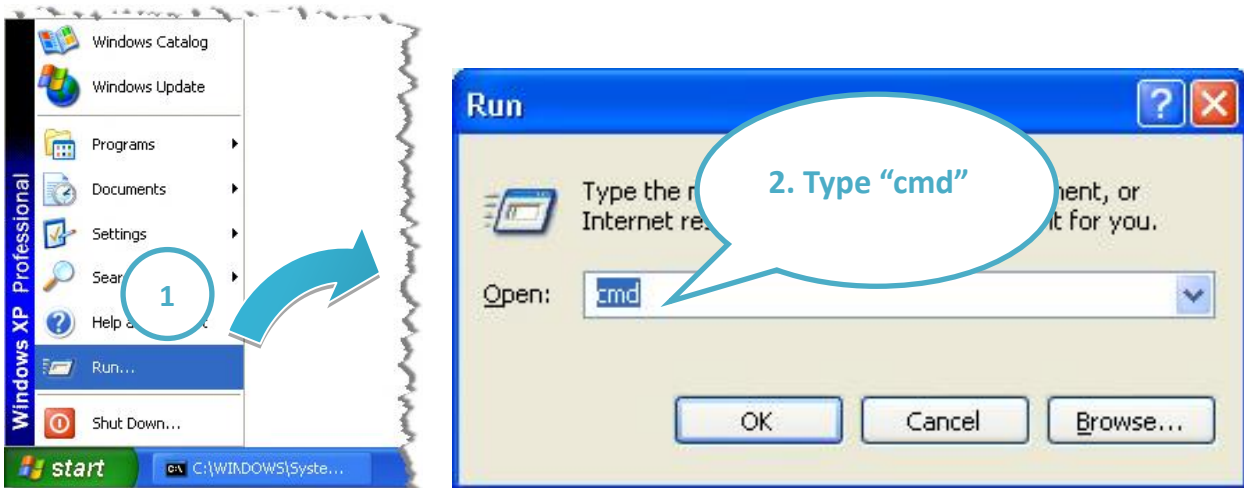

### Step 2: At the command prompt, type "telnet (IP address)"

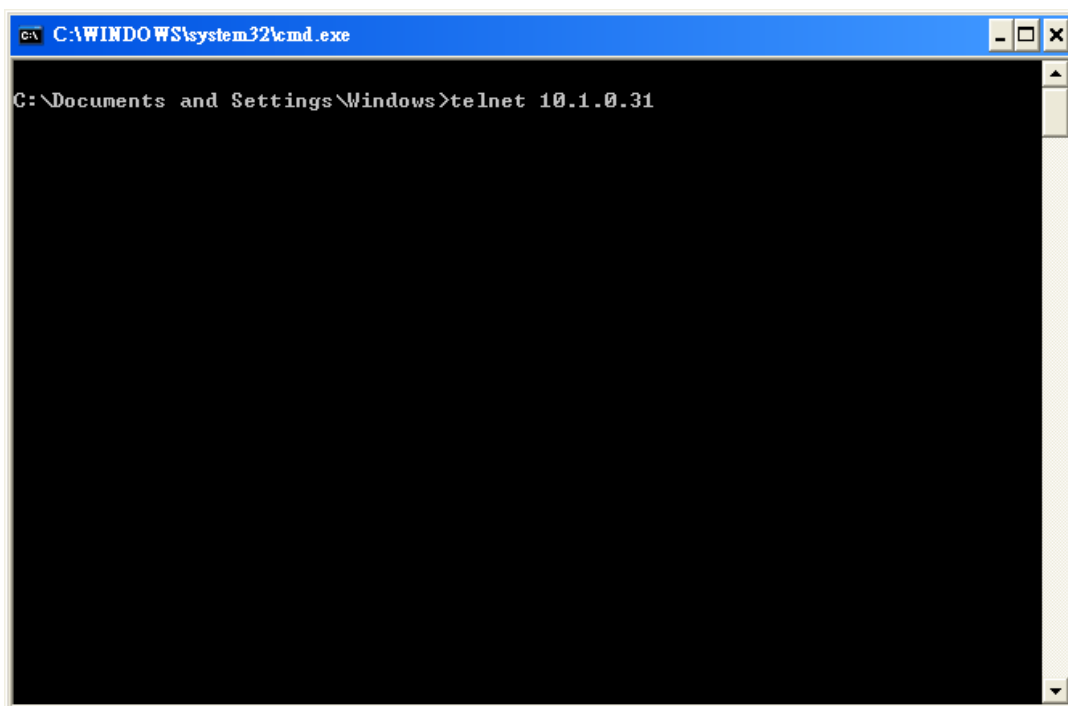

**Step 3: The connection has been set up, and then type the name and password**

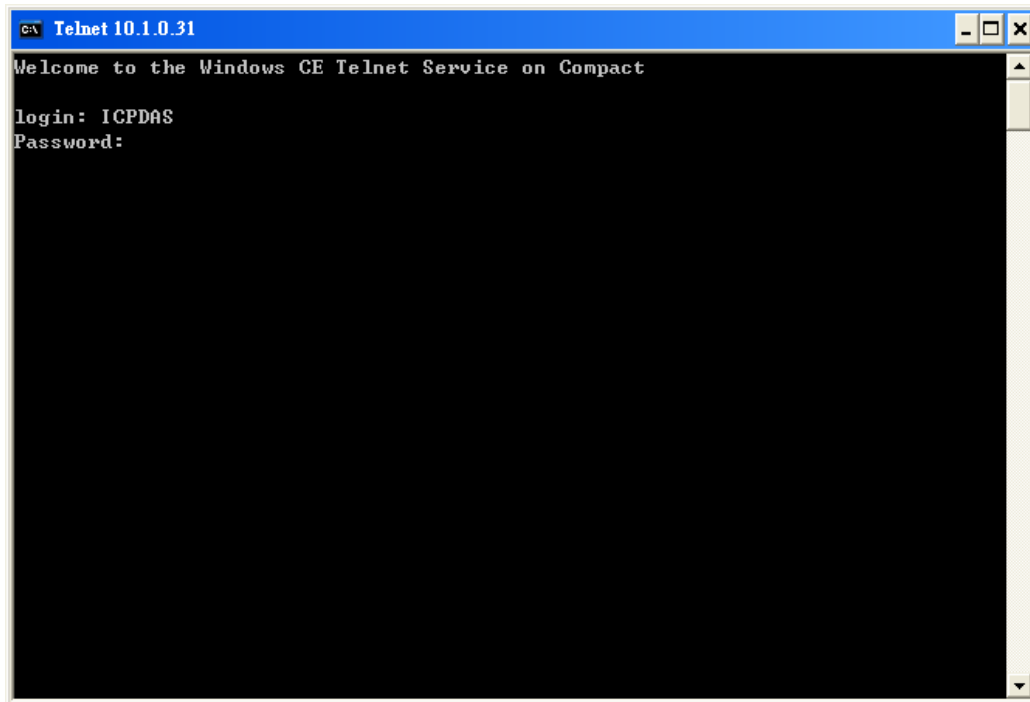

**Step 4: The remote login has been completed**

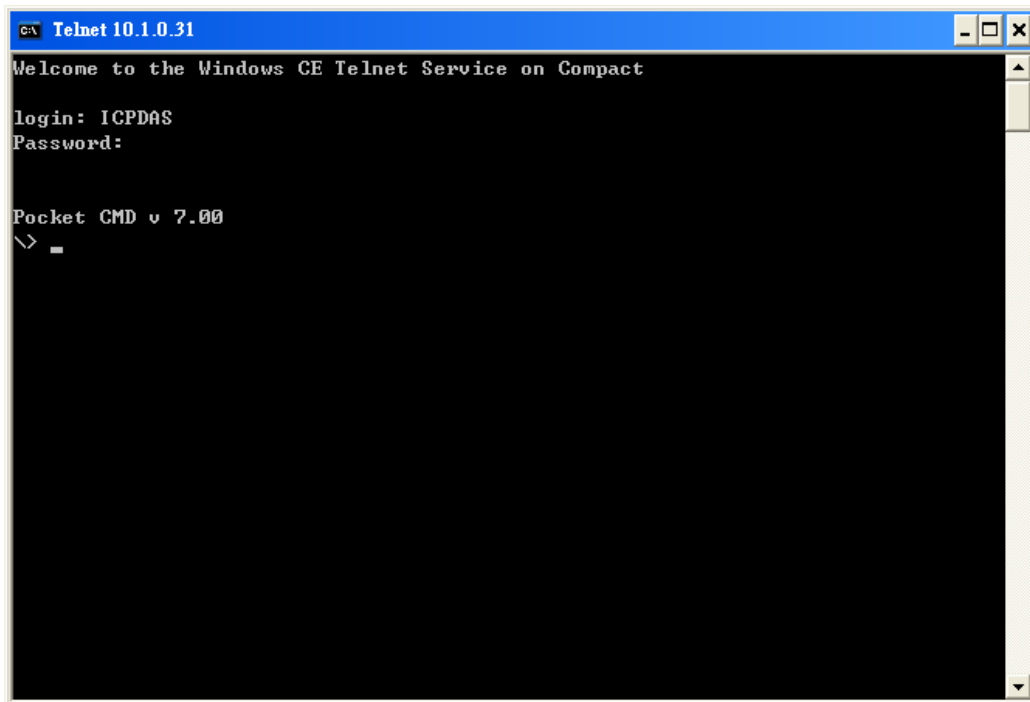

### D.3.How to Remove a User Account from the Login List

Here are step by step instructions on how to remote the user from the login list.

#### Step 1: Run the XPAC Utility



**Step 2: On the Login tab of the Network tab, click Login tab, click a user from the list which you want to remove, and the user will display in the field, and then press Delete to delete the user from the login list**

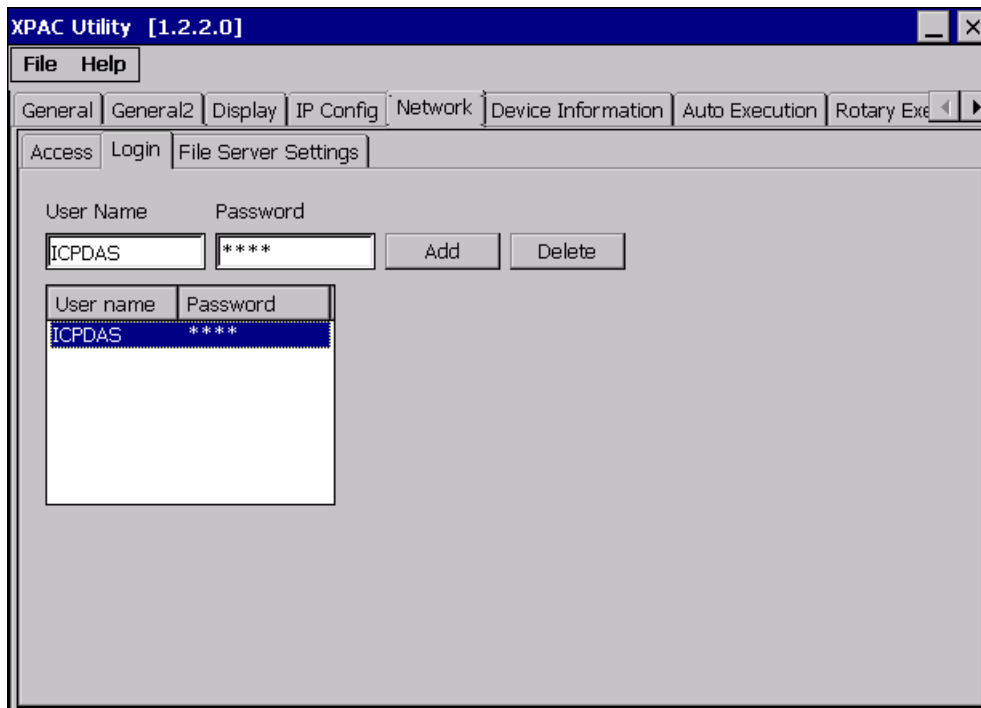



**Step 3: On the File menu, click Reboot for changes to take effect**

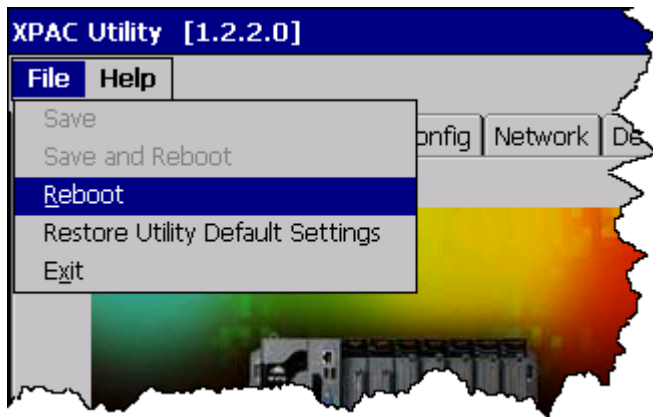

## E. How to use PACSDK library to program the XP-8000-CE6

## E.1. How to Read the XPAC Mode with PACSDK library

The rotary switch is used to set the operating mode.

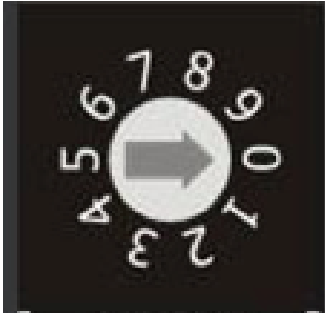

During normal operation, the position of the rotary switch has no effects on XP-8000-CE6. You can use PACSDK API to read back the value of the rotary switch.

```
int pac_GetRotaryID();
```

The returning value of `pac_GetRotaryID()` is what the arrow points to.

## E.2. How to Read the Module ID with XPAC API

The DIP switch can be used to set the Module ID to a number from 0 to 255. Do not use Module ID 0 for communication.

During normal operation, the positions of the DIP switches have no effects on XP-8000-CE6. You can use PACSDK API to read back the value of the DIP switches.

```
int pac_GetDIPSwitch();
```

Below is the figure of DIP switches similar to that of XP-8000-CE6.

The first DIP switch is the LSB and the 8th DIP switch is the MSB.

If the DIP switch slides up to the “ON” side, it represents 1.

If the DIP switch slides down to the number side, it represents 0.

In this way, the eight-bit DIP switches can be represented by 0 ~ 255.

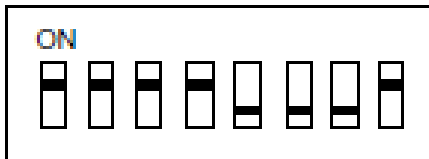

### E.3. How to Use the Multi-IO Module with XPAC API

The Multi-IO Modules tab provides function to check the driver of multi-IO modules, such as 8114, 8144, 8142, and 8112.

For more information about expansion RS-232/RS-422/RS-485 communication module that are compatible with the XP-8000-CE6, please refer to

[http://www.icpdas.com/products/Remote\\_IO/i-8ke/selection\\_rs232\\_i8k.htm](http://www.icpdas.com/products/Remote_IO/i-8ke/selection_rs232_i8k.htm)

1. Insert the multi-IO module into XP-8000-CE6
2. Run the XPAC Utility
3. On the Multi-IO Modules tab, check the driver of the I/O modules

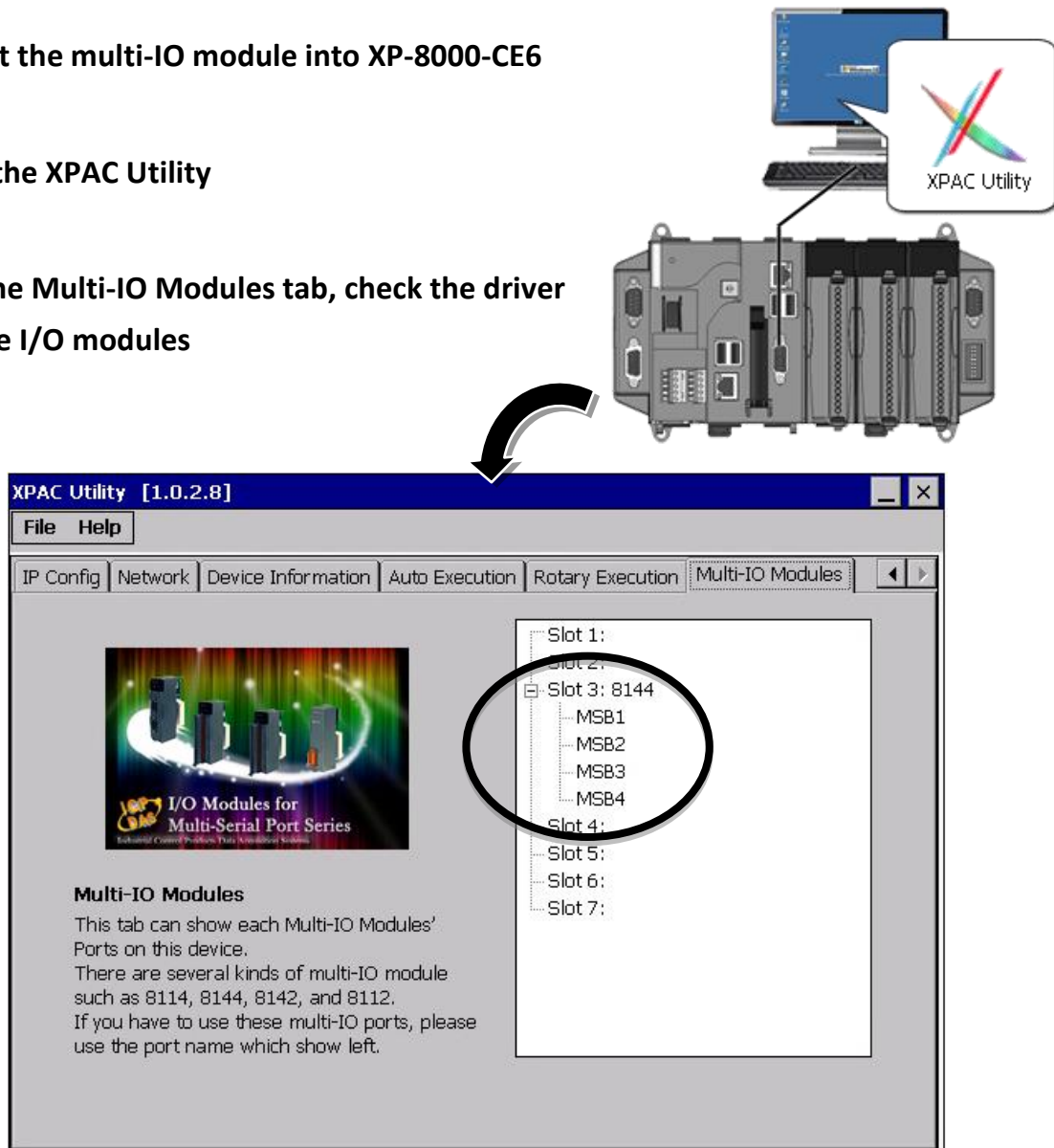

#### 4. Program the multi-IO module

Opening 8144 in Slot 1

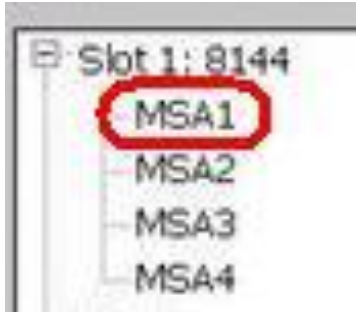

#### Code Snippets

---

```
{  
  BOOL ret;  
  HANDLE hOpen;  
  char buf[4096];  
  
  hOpen = uart_Open("MSA1");  
  ret = uart_SendCmd(hOpen,"$01M", buf);  
  uart_Close(hPort);  
}
```

---

For more information about expansion RS-232/RS-422/RS-485 communication module that are compatible with the XP-8000-CE6, please refer to

[http://www.icpdas.com/products/Remote\\_IO/i-8ke/selection\\_rs232\\_i8k.htm](http://www.icpdas.com/products/Remote_IO/i-8ke/selection_rs232_i8k.htm)

## F. How to update software from XP-8x4x-CE6 or XP-8000-Atom-CE6 to XP-8x3x-CE6

The CPU type of XP-8x4x-CE6 and XP-8000-Atom-CE6 is x86-based and the OS is also Windows CE6.0, so all software are compatible. All old programs and applications on XP-8x4x-CE6 and XP-8000-Atom-CE6 can run smoothly on XP-8x3x-CE6 without any modification and re-compiling. Upgrading applications only just copy and play from XP-8x4x-CE6 or XP-8000-Atom-CE6 to XP-8x3x-CE6.

The software compatibility is listed as following:

### Software compatibility with XP-8x3x-CE6

| Compatibility Comparison   |                              | O: Compatible, X: Incompatible |
|----------------------------|------------------------------|--------------------------------|
| Items                      | Compatibility                |                                |
| OS image                   | X                            |                                |
| Rescue Disk                | X                            |                                |
| VC/C#/VB.net programs      | O                            |                                |
| XPacSDK_CE6 SDK (DLL file) | X                            |                                |
| PACSDK (DLL file)          | O (Since V4.4.0.1 and later) |                                |
| All DCON 8K series library | O                            |                                |
| XPAC utility               | O (Since V1.2.7.3 and later) |                                |
| NAPOPC_CE6                 | O                            |                                |
| Tools on System_Disk       | O                            |                                |

| Compatibility Comparison |             |                  |             | O: Work, X: Doesn't Work |
|--------------------------|-------------|------------------|-------------|--------------------------|
| API Functions            | XP-8x4x-CE6 | XP-8000-Atom-CE6 | XP-8x3x-CE6 |                          |
| pac_EnableLEDs           | X           | O                | O           |                          |
| The others               | O           | O                | O           |                          |

Note: The version of PACSDK must be V4.4.0.1 or later

## G. I-8K and I-87K Modules

I-8K and I-87K modules provide the option to expand the local I/O to 1, 3, or 7 slots and the bus type for the modules can be either parallel (high profile I-8K series) or serial (high profile I-87K series).

The differences between the two module types are listed as follows.

| Item                                      | I-8K Series  | I-87K Series |
|---|--------------|--------------|
| Microprocessor                            | No           | Yes (8051)   |
| Communication Interface                   | Parallel Bus | Serial Bus   |
| Communication Speed                       | Fast         | Slow         |
| Latched DI Function                       | No           | Yes          |
| Counter Input (for digital input modules) | No           | Yes (100 Hz) |
| Power-on Value                            | No           | Yes          |
| Safe Value                                | No           | Yes          |
| Programmable Slew-Rate for AO modules     | No           | Yes          |



## H. Revision History

This chapter provides revision history information to this document.

The table below shows the revision history.

| Revision | Date         | Description   |
|----------|--------------|---|
| 1.0.0    | October 2016 | Initial issue   |
| 1.0.1    | March 2017   | Modified the power specification in section 1.2. Specification        |
| 1.0.3    | March 2018   | Added the information about XP-8031-CE6 in Chapter 1.<br>Introduction |